

MAKE WINNING POSSIBLE™

ATHLETIC EQUIPMENT
CATALOG | 2026

 **TRIGON
SPORTS®**



 PRACTICE PARTNER®





THE NEW HOME OF PROPER PITCH

As a family-owned and operated business with over 60 years of combined experience in the sporting goods industry, Trigon Sports provides high-quality sports equipment for high school, collegiate, and professional programs. Our goal was not to change the sporting goods industry, but simply make it better. Even as our reputation for providing quality sports equipment grew, our reputation for great customer service grew faster.

Through our trademarked brand of sports equipment, ProCage™ and Practice Partner®, we have expanded our product line from baseball and softball, to football, lacrosse, soccer, and more. Our business model is simple: Focus on the customer, provide them with high quality sports equipment, and perhaps most important, love what we do. Here at TSI, we love what we do, and it shows from the moment you call us. We are proud to serve our loyal customers, and even more proud that we help them **"Make Winning Possible"**.

We want to say thank you to all of our local team dealers, team catalog sales reps and loyal customers who use our products every day!

We appreciate you choosing Trigon Sports and we look forward to the opportunity to continue to build relationships with you in the years to come.

It is our pleasure to serve around the globe and help

MAKE WINNING POSSIBLE®



2019
Local Champion



Official Field
Equipment Supplier



Official Field
Equipment Supplier

888-313-1303 • sales@trigonsports.com



CONTENTS

02 PRACTICE PARTNER

Our line of at-home practice equipment to ensure you Make Winning Possible.

06 BASEBALL & SOFTBALL

- 07 Rollaway Batting Cages
- 08 Indoor Electric Batting Cages
- 09 Poly Tunnel Nets & Frames
- 10 Cantilever Batting Cage Frames
- 11 Custom Netting
- 12 Protective Screens
- 17 Ball Caddies
- 18 Training Aids
- 20 Pitching Machines
- 21 Foul Poles
- 22 Halo Kits
- 23 Turf Mats
- 24 Custom Turf
- 25 Pitcher's Mounds
- 29 Pitching Rubbers
- 31 Base Sets
- 32 Field Dirt Products
- 34 Field Maintenance
- 35 Drag Mats
- 36 Dry Liner Markers/Templates
- 37 Field Marking
- 38 Irrigation
- 42 Field Covers & Protectors

- 43 Temporary Fencing
- 45 Fence Protectors
- 46 Fence Screens
- 48 Rail Padding
- 49 Stadium Padding
- 50 Facility Solutions/Indoor Padding

52 BASKETBALL

- 53 Scoreboards
- 54 Ball Carts
- 55 Rims
- 56 Backboards

58 TRAINING

- 59 Sports Speed & Agility

60 FOOTBALL

- 61 Training Aids
- 62 Equipment Storage
- 63 Gameday Field Layout/Equipment
- 64 Sideline Protectors
- 65 Goal Posts
- 66 Dummies/Pads

68 LACROSSE

- 69 Goals

72 SOCCER

- 73 Gameday Field Equipment
- 74 Goals

76 HOCKEY

- 77 Goals/Shooting Target

78 VOLLEYBALL

- 79 Net Systems/Nets
- 80 Rollaway Standards/Training Aids

82 BANNERS

- 83 Sports Banners/Flags

86 BLEACHERS

- 87 Bleacher Enclosures
- 88 Standard Aluminum
- 89 Low-Rise/Tip & Roll
- 90 Supreme Series/ADA Compliant
- 91 Team Benches

INSTALLATION & CONSTRUCTION

We now offer installation of most products!





TRAIN SMARTER. PITCH STRONGER.

- Artificial turf
- Non-slip, non-marking rubber backing
- Lightweight for easy portability
- High-strength construction
- Shock absorbing landing area
- Regulation spec's
- One year limited warranty

FOUND ON PAGE

25

PROPER PITCH

PRACTICE PARTNER

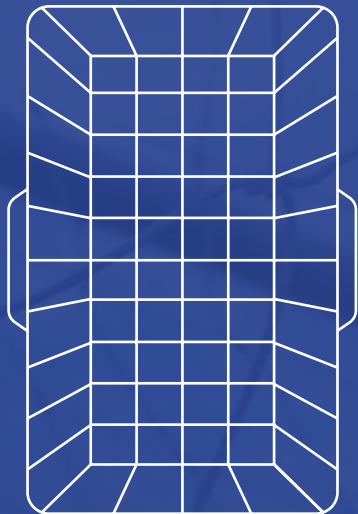

 **PRACTICE PARTNER®**

FROM THE FIELD TO THE BACKYARD.

Practice Partner was founded in 1982 by Joseph Rajacich, a father of two little league ballplayers, who saw the need for a better way to practice at home. Under the leadership of Rajacich's sons, Alex and Andrew, the Practice Partner group of products expanded into a full line of team sports training aids.

Trigon Sports acquired the Practice Partner name and product line in 2021. The acquisition of Practice Partner allows Trigon Sports the ability to offer quality practice equipment to athletes at all levels of play.

BASEBALL

BASEBALL PRO REBOUNDER

Constructed of 1.5" hammered grey powder-coated steel tubing. Swaged joints for easy assembly. Heavy duty polyethylene netting with bungee cords for attachment.

Practice Partner® Pro Baseball Rebounder	PROREB	\$109.00
--	--------	----------



DUAL SPORT THROWING TARGET

Canvas Catcher is made from vinyl and measures 48"W x 75"H. The 2 sided design can be used to practice pitching baseballs, or reversed for practicing your football passes.

Canvas Catcher Throwing Target	BDUSPORT	\$121.55
--------------------------------	----------	----------

NEW!



LACROSSE

LACROSSE WALL REBOUNDER

Constructed of 1.5" 18-gauge steel tubing with 4' x 3' rebounding surface.

Size: 84"T x 36"W



Practice Partner® Lacrosse Wall Rebounder	LPBT	\$260.96
---	------	----------

LACROSSE GOAL



Official size lacrosse goal. Formed from 18-gauge, 1.5" powder-coated steel tubing. Includes 3mm, heavy-duty weatherized netting.

Size: 72"W x 72"H x 84"D

Practice Partner® Lacrosse Goal	LGPRAC	\$204.48
---------------------------------	--------	----------

SILVERLINE PRACTICE LACROSSE GOAL



1.5" powder-coated orange galvanized steel frame. Net laces around frame face and ground supports. 4mm net and lacing cord.

SOLD INDIVIDUALLY.

Practice Partner® Silverline Lacrosse Goal	SLVLG	\$62.56
--	-------	---------

SOCCER

SILVERLINE SOCCER GOALS



Practice Partner® Silverline Soccer Goal 6x9	SLVSG9	\$169.00
Practice Partner® Silverline Soccer Goal 6x12	SLVSG12	\$199.99
Practice Partner® 6'x9' Replacement Soccer Net	SOCNET9	\$85.00
Practice Partner® 6'x12' Replacement Soccer Net	SOCNET12	\$95.00

Silverline soccer goal series comes in two sizes: 9'W x 6'H x 4'D and 12'W x 6'H x 4'D. Goals are great for all levels and ages of soccer. Goals are constructed of a 1 5/8" diameter, 18-gauge steel tubing. Includes a professional quality, heavy-duty weatherized net.

6X9 SOCCER REBOUNDER



Assembles to 6'H x 9'W. Precision-fit locking pins for easy assembly. Constructed of 1.5", 18-gauge heavy-duty steel tubing.

Practice Partner® Soccer Rebounder	SOCREB	\$114.40
---------------------------------------	--------	----------

4X8 FOLDING SOCCER GOAL



Foldable goal features push-button assembly and all-weather net. Perfect portable goal for practice.

Size: 4'H x 6'W x 3'D

Practice Partner® Folding Soccer Goal	FOLD95	\$74.36
--	--------	---------

HOCKEY

HOCKEY GOAL



2" galvanized steel tubing with weather-treated red powder coat. Pro style round back frame. Doubled welded net attachment system. 4mm heavy duty weatherized netting.

Practice Partner® Hockey Goal	RHX2	\$107.25
----------------------------------	------	----------

SILVERLINE HOCKEY GOAL



1 5/8" 18-gauge steel tubing with weather-treated red powder coating. Pro style round back frame. 4mm heavy duty weatherized netting.

Size: 72"W x 48"H x 36"D

Practice Partner® Silverline Hockey Goal	SLVRHR	\$120.00
---	--------	----------





NEW!

PRACTICE PARTNER PORTABLE SOCK SCREEN AND BALL BASKET

Make practice more efficient with the Practice Partner Portable Sock Screen and Ball Basket. Featuring a durable sock-style net for collecting balls with a pop-up ball basket for easy access, this lightweight and portable design is perfect for batting practice, soft toss, or pitching drills. Quick to set up, tough enough for daily use, and convenient for coaches or athletes on the go.

Practice Partner Portable Sock Screen and Ball Basket

PPSOCK

BASEBALL & SOFTBALL



FEATURED PRODUCT



ROLLAWAY BATTING CAGE BPCAGE



STANDARD FEATURES

- Overall dimensions: 22'D x 18'W x 12'H
- Collapsed storage height is 5'
- Rear dolly assembly easily lifts & maneuvers cage
- Dual, fold-out coaches platforms at rear of cage allow for raised viewing of batter
- Complete Rollaway Cage includes: Net, Heavy-duty vinyl skirt & thud pad
- Frame structure is 2" O.D. heavy wall aluminum tubing
- Large 10' x 10' baffle net to protect rear of cage
- Heavy-duty weather-treated knot-less netting - replacement net
- Replacement heavy-duty vinyl skirt (Black)
- Outer wheels turn 180 degrees and feature locking hubs with oversized turf tires

Rollaway Batting Cage	BPCAGE	\$7,293.00
-----------------------	--------	------------

Dual Fold-Out Coaches Platforms At Rear Of Cage



UPGRADES

Replacement Heavy-Duty Vinyl Skirt (Black)	BPCAGESKT	\$604.88
Replacement Thud Pad (Black)	BPCAGEPAD	\$434.71
Replacement Net	BPCAGEN	\$1272.69

SHIPS FREIGHT. UNIT NOT DESIGNED FOR TOWING.

SKIRT & PAD WRAP COLOR KITS



COLOR	SKIRT	PAD WRAP COLOR KIT	MRSP
Dark Green	BCSKTDG	BCPADDG	\$567.70
Purple	BCSKTPU	BCPADPU	\$567.70
Navy Blue	BCSKTNA	BCPADNA	\$567.70
Royal Blue	BCSKTRO	BCPADRO	\$567.70
Red	BCSKTRD	BCPADRD	\$567.70

Color Skirt and Pad Wrap Kits Available



INDOOR ELECTRIC BATTING CAGES

INDOOR ELECTRIC MULTI-SPORT BATTING CAGE



Our Indoor Electric Multi-Sport Batting Cage is conveniently suspended from the ceiling structure and electrically operated. Our team will provide cut sheets to build to your specific dimensions. The drive shaft raises and lowers the system, powered by our curtain hoist. This Indoor Electric Batting Cage also comes with a 1-Year Limited Warranty. Ship time is dependent upon receipt of gymnasium dimension verification. This item includes custom-size ceiling structure only. Batting Tunnel net is NOT included. Please call for further details.

55' Custom Cage	B51055	\$8,758.75
70' Custom Cage	B51070	\$9,867.00

Pricing may vary depending on building structure

1/4" SPRING CLIPS



1/4" Spring Clips, 42ct	SNAP42	\$50.05
-------------------------	--------	---------

BATTING CAGE SUSPENSION/INSTALLATION KIT

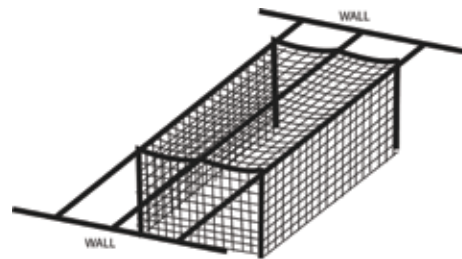

KIT INCLUDES:

- (3) 3/16" x 100' Galvanized Steel Wire Cables
- (6) Wire Rope Clamps
- (6) Hook & Eye Turnbuckles
- (6) 1/2" x 12" Eye-bolts
- (42) Snap Links

Can be used for indoor suspension kit or outdoors as installation hardware for your existing frame.

NOW INCLUDES ROLLER PULLEYS FOR EASIER NET MOVEMENT.

ProCage™ Batting Cage Installation Kit	B50010	\$403.33
--	--------	----------

INDOOR CEILING SUSPENSION KIT



KIT INCLUDES:

- (3) 3/16" x 100' Galvanized Steel Wire Cables
- (30) 3/16" x 30' Galvanized Steel Wire Cables
- (66) Wire Rope Clamps
- (6) Hook & Eye Turnbuckles
- (6) 1/2" x 12" Eye-bolts
- (60) Snap Links

NOW INCLUDES ROLLER PULLEYS FOR EASIER NET MOVEMENT.

ProCage™ Indoor Ceiling Suspension Kit	B50015	\$662.00
--	--------	----------

POLY BATTING TUNNEL NETS



AVAILABLE IN BOTH #42 THREAD WITH A 5-YEAR WARRANTY AND #24 THREAD WITH A 2-YEAR WARRANTY.

Constructed of heavy-synthetic HDPE fiber, extruded with permanent black color and sunlight/UV inhibitors throughout each filament. 1-3/4" mesh size. High abrasion resistant twisted-knotted netting, strongest form of netting in commercial use. 100% waterproof and low-stretch = no sagging. Heavy-Duty rope reinforcement on all edges, corners and top hanging ropes.

#42 THREAD 2.5 mm diameter. #60 (380d/60) denier			
NET SIZE	WEIGHT	ITEM#	MRSP
75'Lx15'Wx12'H	130 lbs.	B427515	\$1,182.61
70'Lx24'Wx12'H	200 lbs.	B427024	\$1,637.35
70'Lx14'Wx14'H	125 lbs.	B427044	\$1,076.79
70'Lx14'Wx12'H	120 lbs.	B427014	\$1,112.54
70'Lx12'Wx12'H	115 lbs.	B427012	\$1,049.62
55'Lx14'Wx14'H	105 lbs.	B425544	\$950.95
55'Lx14'Wx12'H	100 lbs.	B425514	\$900.90
55'Lx12'Wx12'H	95 lbs.	B425512	\$829.40
INCLUDES ENTRY DOOR W/ BAFFLE			
70'Lx14'Wx12'H	125 lbs.	B427014F	\$1,289.86
55'Lx14'Wx12'H	105 lbs.	B425514F	\$1,049.62

U.S. twine size as standardized by American manufacturers and the American Cordage Institute.

Do not be confused by those that refer to the thread count as U.S. twine size.

#24 THREAD 2.8 mm diameter. #42 (380d/42) denier			
NET SIZE	WEIGHT	ITEM#	MSRP
70'Lx14'Wx12'H	75 lbs.	B247014	\$837.98
70'Lx12'Wx12'H	70 lbs.	B247012	\$786.50
55'Lx14'Wx12'H	70 lbs.	B245514	\$674.96
55'Lx12'Wx12'H	65 lbs.	B245512	\$629.20
35'Lx14'Wx12'H	46 lbs.	B243514	\$536.25

DIVIDER NETTING

#42 Polyethylene thread with a rope border on all four sides. Attach behind batting & pitching areas to prolong net life, or hang in middle of tunnel for 2 hitting stations.

14'x12' Baffle Netting	B421412	\$130.12
------------------------	---------	----------



BATTING CAGE ZIP DOOR



Add a door entry to any batting cage in minutes. Marine-grade vinyl that attaches using super stick Velcro & snaps. Simply cut an opening and attach.

Size: 70"H x 24"W with a 64" zipper door opening.

(Patent Pending)

Batting Cage Zip Door	BPZIPD	\$226.64
-----------------------	--------	----------

TUNNEL CAGE SAVERS

★ BEST SELLER!

Made of tough vinyl, lengthen the life of your batting cage nets with our cage savers. Includes brightly colored strike zone and comes with brass grommets and poly rope in corners for attachment.

Heavy-Duty 22 oz. wVinyl, 4'x6'	BSVR22	\$64.35
Heavy-Duty 30 oz. Vinyl, 5'x7'	BSVR30	\$235.95

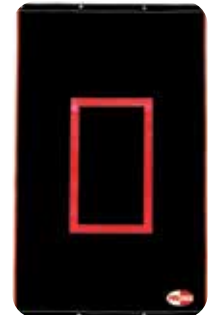

Color Options: 22oz. Vinyl - Black with Red Strike Zone, 30oz Vinyl - Blue with Yellow Strike Zone, Black with Orange Strike Zone



CANTILEVER BATTING CAGE FRAME

INDIVIDUAL
POLES OR
CUSTOM SET-UPS
AVAILABLE

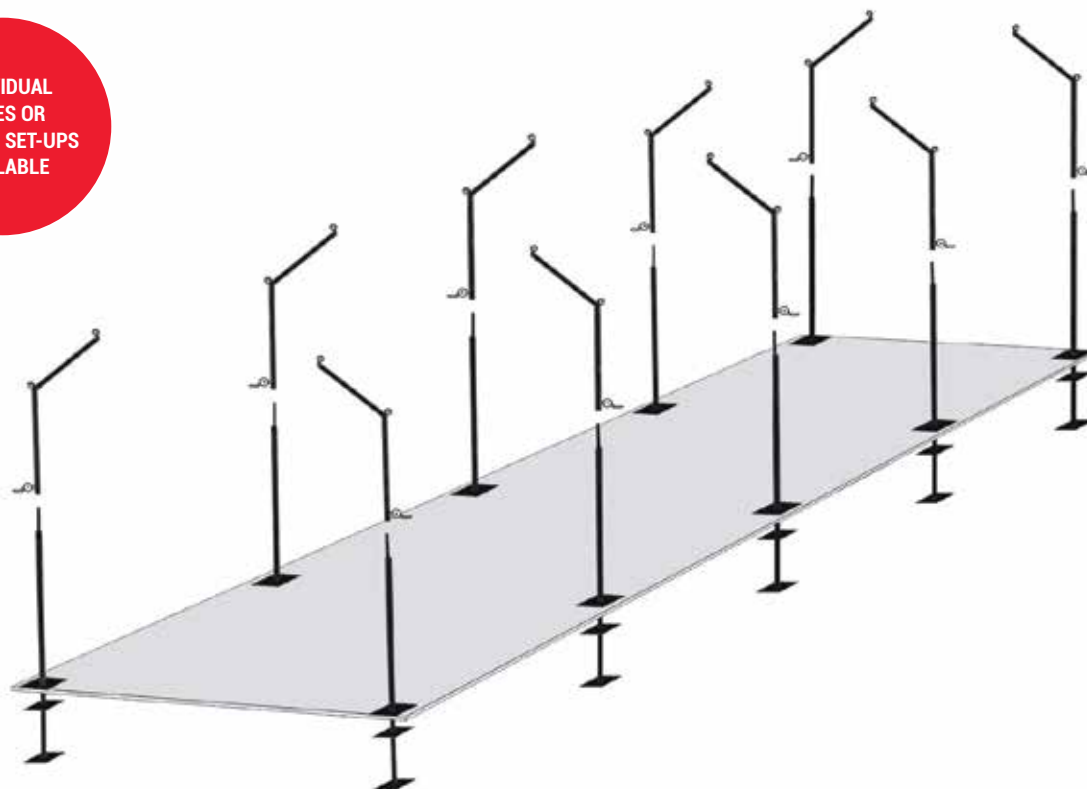

14' W x 14' H TUNNEL NET IS RECOMMENDED FOR ALL CANTILEVER CAGES.

Call us today and see how we can make this frame meet your needs.

8-Poles & Ground Sleeves with Hardware Kit	BCFRM55	\$3,632.43
10-Poles & Ground Sleeves with Hardware Kit	BCFRM70	\$4,540.54
Single Pole & Ground Sleeves with Hardware Kit	BCFRM	\$544.82
1/4" Spring Clips, 42ct	SNAP42	\$50.05

New design, features 2-piece pole assembly with cantilever top and individual winch on each pole makes net set up and take down quick and easy!

NO LADDERS NEEDED!



PRE-CUT BARRIER NETTING



Made of Black #42 knotted thread that is weather and UV treated. 13/4" square mesh with a sewn rope border on all sides. Perfect for use as a barrier net for baseball or softball.

14'x50' Pre-Cut Netting	BN1450	\$435.42
14'x100' Pre-Cut Netting	BN14100	\$848.69

CUSTOM NETTING

Custom nets are made to your specification to cover any sport or application. We offer nets hung on the diamond or on the square and your choice of rope borders or vinyl tape with grommets. Please contact us with your measurements and application. Netting is our specialty!



DYNEEMA



ITEM NUMBER	CN250	CN21	CN371	CN504	CN42	CN361	CN60	CN96	CND18
MSRP	\$0.80	\$0.63	\$1.34	\$0.70	\$0.80	\$0.80	\$1.52	\$2.72	\$2.79
Mesh Size	1"	1-3/4"	3/4"	4"	1-3/4"	1-3/4"	1-3/4"	1-3/4"	1-3/4"
Colors Available	BLACK	BLACK	BLACK, BLUE	BLACK, WHITE	BLACK	BLACK	BLACK	BLACK	BLACK
Cord Diameter (mm)	1.8	1.8	2.3	2.3	2.7	2.5	3.0	4.0	1.7
Applications									
Baseball Backstop					✓	✓	✓	✓	✓
Basketball Court Netting	✓	✓	✓	✓	✓	✓	✓	✓	✓
Batting Cage/Tunnel					✓	✓	✓	✓	✓
Discus Cage Netting					✓	✓	✓	✓	✓
Football Field Netting				✓	✓	✓	✓	✓	✓
Foul Ball Barrier		✓			✓	✓	✓	✓	✓
Golf Perimeter Net	✓		✓						
Golf Practice Panel/Tunnel			✓						
Hockey Barrier							✓	✓	
Indoor Baseball Facilities		✓			✓	✓	✓	✓	✓
Indoor Soccer Facilities		✓		✓	✓	✓	✓	✓	✓
L-Screen					✓	✓	✓	✓	
Lacrosse Barrier Net			✓		✓	✓	✓	✓	✓
Racquet Ball Barrier	✓	✓	✓						
Soccer Barrier		✓		✓	✓	✓	✓	✓	
Soccer Goals					✓	✓	✓	✓	
Tennis Barrier/Divider	✓	✓			✓	✓	✓		

PRO SCREENS

ALL PRO SCREENS FEATURE:

- Heavy-duty 4.0mm #96 thread knotted pillowcase style net
- Heavy-gauge 2" galvanized steel frame
- Heavy-duty wheel kit with no-flat turf tires
- Heavy-duty wheel protectors

8-10' FRAME PADDING KIT

3 8' Sections Vinyl w/ Lacing Twine

RECOMMENDED ON ALL SCREENS

8' Black Frame Padding Kit	BPROPAD	\$127.26
Green Frame Padding Kit	BPROPADGR	\$127.26
Red Frame Padding Kit	BPROPADRD	\$127.26
Blue Frame Padding Kit	BPROPADBL	\$127.26



PROCAGE™ "OLE 96ER" PRO L-SCREEN



Complete L-Screen	BLPRO96	\$715.00
Replacement L-Screen Net	BLPRO96N	\$260.96

PROCAGE™ "OLE 96ER" FUNGO SCREEN



FRAME PADDING KIT RECOMMENDED

Fits 8'-10' frame padding kits

Complete Fungo Screen	BFPRO96	\$715.00
Replacement Fungo Net	BFPRO96N	\$275.26

PROCAGE™ PROFESSIONAL 10'X10' PROTECTIVE SCREEN



FRAME PADDING KIT RECOMMENDED

Fits 8'-10' frame padding kits

Complete 10'x10' Screen	BFPRO10	\$886.60
Replacement 10'x10' Net	BFPRO10N	\$313.16

PROCAGE™ MINI PRO L-SCREEN



FEATURES:

- Size: 5'W x 7'H
- Heavy-duty 4.0mm thread knotted pillowcase style net
- Heavy-gauge 2" galvanized steel frame
- Heavy-duty wheel kit with no-flat turf tires
- Heavy-duty fabric wrapped foam encases entire frame
- Heavy-duty wheel protectors

Complete Padded Mini L-Screen	BLPRO57	\$572.00
Replacement Mini L-Screen Net	BLPRO57N	\$181.60

PROCAGE™ PRO #96 DOUBLE L-SCREEN W/ HOOD

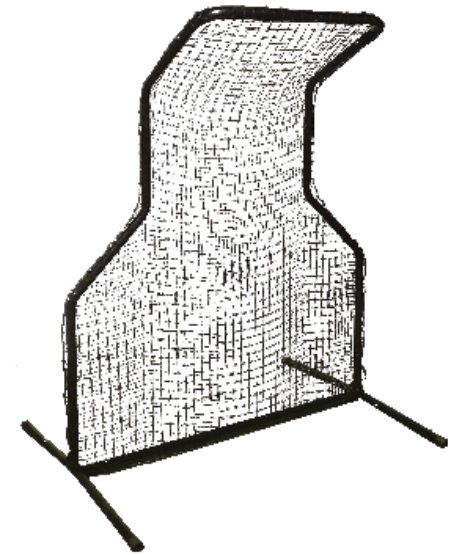

FEATURES:

- Size: 6' x 94" (42"W at top)
- 2' deep slanted protective hood
- Heavy duty 2" steel frame
- Heavy-duty 4.0mm thread knotted pillowcase style net
- Fully padded

Complete Double L-Screen with Hood	BLPRODB	\$643.50
------------------------------------	---------	----------

NET REPAIR KIT

Net repair/lacing kit. Includes 11lb spool of black #36 tarred nylon twine and net repair lacing needle.



Net Repair/Lacing Kit	BNETREP	\$22.88
-----------------------	---------	---------

SUPREME SCREENS

ALL SUPREME SCREENS FEATURE:

- Double 3.0mm knotted netting
- 1.5mm heavy wall steel tubing
- 1-1/2" round hammer powder coat finish
- Push-button assembly
- Detachable legs for easy storage

PITCHER'S L-SCREEN PROTECTIVE SCREEN

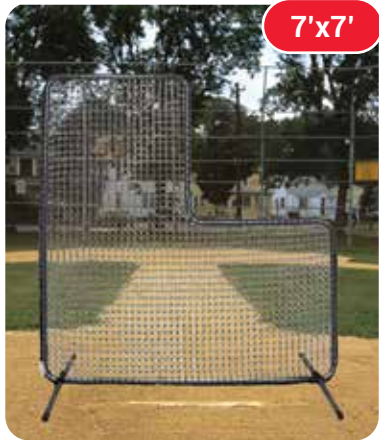

7'x7'

FRAME PADDING KIT RECOMMENDED

Fits 7' frame padding kits

Complete Pitcher's L-Screen	B607744	\$386.09
Replacement L-Screen Net	B607744N	\$204.48

FIRST BASE FUNGO PROTECTIVE SCREEN



7'x7'
#60 NETTING

FRAME PADDING KIT RECOMMENDED

Fits 7' frame padding kits

First Base Fungo Screen	B607720	\$369.64
Replacement Screen Net	B607720N	\$195.18

7' FRAME PADDING KIT

3-7' Sections Vinyl w/ Lacing Twine

RECOMMENDED ON ALL SCREENS



7' Black Frame Padding Kit	B77PAD	\$110.81
Green Frame Padding Kit	B77PADGR	\$110.81
Red Frame Padding Kit	B77PADRD	\$110.81
Blue Frame Padding Kit	B77PADBL	\$110.81

PROCAGE™ UNIVERSAL WHEEL KIT



Add this wheel kit to any round or square tube screen for additional mobility on and off the field!

FITS ALL SQUARE AND ROUND TUBE FRAMES UP TO 1-3/4".

FEATURES:

- Heavy-duty steel construction
- Large turf-type wheels
- Dual clamps for secure attachment

ProCage™ Universal Wheel Kit	BWHLKIT	\$91.51
------------------------------	---------	---------

NET REPAIR KIT

Net repair/lacing kit. Includes 1lb spool of black #36 tarred nylon twine and net repair lacing needle.



Net Repair/Lacing Kit	BNETREP	\$22.88
-----------------------	---------	---------

Z-SCREEN PROTECTIVE PITCHING SCREEN



7'x5'

FRAME PADDING KIT RECOMMENDED

Fits 7' frame padding kits (as Shown)

Complete Z-Screen	B6075Z	\$240.24
-------------------	--------	----------

PROCAGE FUNGO SCREEN WITH HOOD



NEW!

8'x4'
#60 NETTING

BLACK PAD KIT INCLUDED

ProCage Protective Screen	BSQ6084	\$345.00
---------------------------	---------	----------

PREMIUM SCREENS

ALL PREMIUM SCREENS FEATURE:

- Double 2.5mm #42 pillowcase style net
- Constructed of 1-3/4" galvanized square steel frame
- Swaged joints and push-button assembly
- Detachable legs for storage

FRAME PADDING KIT RECOMMENDED

7' FRAME PADDING KIT

3-7' Sections Vinyl w/ Lacing Twine

RECOMMENDED ON ALL SCREENS



7' Black Frame Padding Kit	B77PAD	\$110.81
Green Frame Padding Kit	B77PADGR	\$110.81
Red Frame Padding Kit	B77PADRD	\$110.81
Blue Frame Padding Kit	B77PADBL	\$110.81

PROCAGE™ MINI FUNGO SCREEN



Complete Mini Fungo Screen	BSQ4274	\$249.52
Replacement Mini Fungo Net	BSQ4274N	\$113.67
Mini Fungo Screen Padding Kit (8 Sections vinyl w/lacing twine)	BSQ4274P	\$104.38

SOFTBALL PITCHER'S C-SCREEN



FRAME PADDING KIT RECOMMENDED

Fits 7' frame padding kits

Softball Pitcher's C-Screen	B427790	\$295.28
Replacement C-Screen Net	B427790N	\$166.58

SOFT TOSS SOCK NET SCREEN



FRAME PADDING KIT RECOMMENDED

Fits 7' frame padding kits

Soft Toss Sock Net Screen	B427700V	\$363.21
Replacement Soft Toss Sock Net	B427700N	\$152.28

PREMIUM SCREENS

PITCHER'S PROTECTIVE L-SCREEN



FRAME PADDING KIT RECOMMENDED
Fits 7' frame padding kits

Complete L-Screen	B427744	\$295.28
Replacement Screen Net	B427744N	\$130.12

SOFTBALL PITCHER'S PROTECTIVE SCREEN

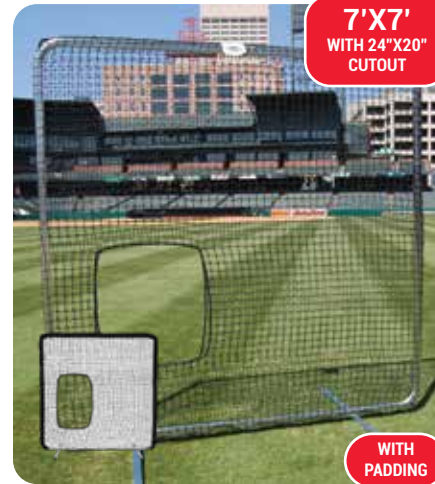

FRAME PADDING KIT RECOMMENDED
Fits 7' frame padding kits

Softball Pitcher's Screen	B427780	\$295.28
Replacement Screen Net	B427780N	\$130.12

FIRST BASE FUNGO PROTECTIVE SCREEN



FRAME PADDING KIT RECOMMENDED
Fits 7' frame padding kits

First Base Fungo Screen	B427720	\$295.28
Replacement Screen Net	B427720N	\$130.12

FRAME PADDING KITS RECOMMENDED FOR ALL SCREENS



Heavy duty vinyl wrapped foam padding with grommets. Lacing twine is included to securely attach to square or round tube frames.



8'-10' Padding Kit	BPPROPAD	\$127.26
Black	BPPROPADGR	\$127.26
Green	BPPROPADRD	\$127.26
Red	BPPROPADBL	\$127.26
Blue		
7' Padding Kit Black	B77PAD	\$110.81
Green	B77PADGR	\$110.81
Red	B77PADRD	\$110.81
Blue	B77PADBL	\$110.81
Mini Fungo Padding Kit	BSQ4274P	\$104.38

BLACK SERIES SCREENS

ALL BLACK SERIES SCREENS FEATURE:

- Waterproof double-pillowcase netting
- Sturdy 18-gauge powder-coated 1-1/2" round steel frame
- Push-button for easy assembly
- Screen is retail packaged with UPC barcode
- Detachable legs for storage

PITCHER'S PROTECTIVE L-SCREEN



FRAME PADDING KIT RECOMMENDED

Fits 7' frame padding kits

Complete L-Screen	BSL77P	\$204.48
Replacement Screen Net	B427744N	\$130.12

7'X7' FIRST BASE FUNGO SCREEN



FRAME PADDING KIT RECOMMENDED

Fits 7' frame padding kits

7'x7' First Base Fungo Screen	BSL77F	\$204.48
Replacement Screen Net	B427720N	\$130.12

FRAME PADDING KITS RECOMMENDED FOR ALL SCREENS



Heavy duty vinyl wrapped foam padding with grommets. Lacing twine is included to securely attach to square or round tube frames.



8'-10' Padding Kit Black	BPPROPAD	\$127.26
Green	BPPROPADGR	\$127.26
Red	BPPROPADRD	\$127.26
Blue	BPPROPADBL	\$127.26
7' Padding Kit Black	B77PAD	\$110.81
Green	B77PADGR	\$110.81
Red	B77PADRD	\$110.81
Blue	B77PADBL	\$110.81
Mini Fungo Padding Kit	BSQ4274P	\$104.38

SOFT TOSS SOCK NET PROTECTIVE SCREEN



FRAME PADDING KIT RECOMMENDED

Fits 7' frame padding kits

7'x7' First Base Fungo Screen	BSL77S	\$249.52
Replacement Screen Net	B427700N	\$152.28

SOFTBALL PITCHER'S PROTECTIVE SCREEN



FRAME PADDING KIT RECOMMENDED

Fits 7' frame padding kits

7'x7' First Base Fungo Screen	BSL77SB	\$204.48
Replacement Screen Net	B427780N	\$130.12

10'X10' FIRST BASE FUNGO SCREEN



FRAME PADDING KIT RECOMMENDED

Fits 8'-10' frame padding kits

10'x10' First Base Fungo Screen	BSL10F	\$295.28
Replacement Screen Net	BSL10FN	\$158.72



TRI-FOLD SCREENS

TRI-FOLD PROTECTIVE SCREEN



FEATURES:

- Main panel is 8'x8' with (2) 8'x4' wings.
- Includes wheels & ground anchor stakes
- New design features four legs for added stability

OVERALL SIZE:

Our ProCage™ Tri-Fold Screen features a 1^{1/2} inch powder coated steel frame with waterproof pillowcase netting. Screen includes wheels for transport and ground anchor stakes for added stability.

Tri-Fold Protective Screen	BTRIFLD	\$408.25
Replacement Tri-Fold Screen Net	BTRINET	\$158.72

BALL CADDIES

BATTING PRACTICE BALL CADDY



Caddy can be used while sitting or standing by easily adjusting leg height. Legs adjust to 24", 30" and 36" heights. Comes with wheels for easy transport on and off the field. Holds up to 60 baseballs or 36 softballs.

Batting Practice Ball Caddy	BPCAD	\$149.42
Replacement Bag	BPCADMB	\$40.74

PROCAGE PROFESSIONAL BALL CART

PRO'S CHOICE



HD powder-coated steel frame with a premium mesh netted ball basket. Sturdy and durable with no-flat turf tires. NEW wheel protectors. Push-button assembly. Dolly-style design for easy transport. Holds 300 baseballs and approximately 150 softballs. Great for all levels of play.

PROCAGE PROFESSIONAL BALL CART	BPCADP	\$290.28
REPLACEMENT NET	BPCADPN	\$52.18

TRAINING AIDS

THE DESIGNATED HITTER



Life-like, silhouette figure of a batter stands in at the plate in place of a real batter, adding the element of a more game-like setting to pitching practice.

Available in: Red, Blue and Gray

DESIGNATED HITTER PRO MODEL	DHPROBL	\$490.49
DESIGNATED HITTER PRO MODEL	DHPRO-GREY	\$500.50
DESIGNATED HITTER PRO MODEL	DHPRORD	\$490.49



STANDARD BATTING TEE



Mounted on an official rubber home plate. Molded rubber design with inner steel support tube. Inner sleeve adjusts from 22" to 47" to accommodate batters of all sizes.

STANDARD BATTING TEE	BBTEE	\$34.31
----------------------	-------	---------

HANGING BALL HOLDERS



Features an all steel, welded construction powder-coated black for maximum protection. Holders store up to 10 balls.

BASEBALL HOLDER	BBHLD	\$27.87
SOFTBALL HOLDER	SBHLD	\$27.87

DELUXE BATTING TEE



Mounted on an official rubber home plate. Features a reinforced tube base. Inner sleeve adjusts from 22" to 47" to accommodate batters of all sizes. Molded rubber design features a built-in carry handle.

DELUXE BATTING TEE	BDTEE	\$42.17
--------------------	-------	---------

HANGING BAT RACK



All steel construction, powder-coated black for maximum protection. Hanging arms swivel for easy use and storage. Rack holds 10 bats.

Size: 30" wide

HANGING BAT RACK	BHRACK	\$43.60
------------------	--------	---------

FOLDING BATTING TEE



Molded rubber design. Adjustable height from 30"-46". Folding base makes it travel easy.

FOLDING BATTING TEE	BFTEE	\$56.47
---------------------	-------	---------



TRAINING AIDS

9-HOLE PITCHING TARGET TRAINER

★ BEST SELLER!



FEATURES:

- Size: 46"H x 36"W
- Target zone: 42"H x 36"W
- 2" steel frame
- Knotless nylon netting with nine netting pockets
- Vinyl padding with yellow target zone

9-Hole Pitching Trainer	BPTRAIN9	\$340.33
Red Pad Kit	TRN9PADRD	\$58.00
Royal Pad Kit	TRN9PADRO	\$58.00
Dark Green Pad Kit	TRN9PADDG	\$58.00
9-Hole Pitching Trainer Replacement Net	BPTRAIN9N	\$107.90

PRO ADJUSTABLE 9-HOLE TARGET



FEATURES:

- Target zone: 30"H x 26"W
- 2" steel frame
- Adjusts to three height settings up to 4'
- Knotless nylon netting with nine netting pockets
- Vinyl padding with yellow target zone
- Ideal for evaluating pitcher accuracy at all skill levels



Pro Adjustable 9-Hole Target Pitch Trainer	BPTRAIN9PRO	\$383.23
Red Pad Kit	PROPADRD	\$38.00
Royal Pad Kit	PROPADRO	\$38.00
Dark Green Pad Kit	PROPADDG	\$38.00

MULTI-SPORT PITCH BACK REBOUNDER

★ BEST SELLER!



1 1/4" hammered grey powder coated steel tubing. Swaged joints with thumb snaps for easy assembly. Adjustable to multiple angles for play on both sides. Heavy-duty polyethylene netting with bungee cords for attachment. Includes a 1" red target interlaced into netting.

Size: 72"T x 42"W

Multi-Sport Pitch Back Rebounder	MSPB427	\$113.67
Multi-Sport Pitch Back Rebounder Replacement net	MSPB427N	\$45.03

BASEBALL PRO REBOUNDER



Constructed of 1.5" hammered grey powder-coated steel tubing. Swaged joints for easy assembly. Heavy duty polyethylene netting with bungee cords for attachment.

Practice Partner® Pro Baseball Rebounder	PROREB	109.00
--	--------	--------

TRAINING AIDS

I-HACK ATTACK BASEBALL PITCHING MACHINE



TOUCH SCREEN INTERFACE:

With the familiar look and feel of a personal tablet, the machine interface is a customized touch screen through which you can control and select pitch type, speed and spin as well as access saved favorite pitches and sequences.

ADVANCED SOFTWARE PROGRAM:

Using touch screen, quickly go between eight different pre-set pitches as well as pre-set defensive drills.

All pitches can be modified as desired by making finite adjustments to each motor individually.

FEATURES:

- Great for all levels of baseball.
- Throws fastballs, curves, sliders, split fingers and Knuckleballs.
- Pivots instantly for pop-ups, flyballs, grounders and catcher's pop-ups.

I-Hack Attack Baseball Pitching Machine	BIHACK	\$5,599.00
---	--------	------------

HACK ATTACK PITCHING MACHINE



The exclusive three-wheel design of the Hack Attack Baseball Pitching Machine allows the hitter to see the ball clearly all the way through the feeding motion, acceleration and release, just like with a live pitcher.

FEATURES:

- Can be used for all levels of baseball.
- Throws fastballs, curves, sliders, split fingers and Knuckleballs.
- Pivots instantly for pop-ups, flyballs, grounders and catcher's pop-ups.
- Can be converted to softball.

Hack Attack Baseball Pitching Machine	BHABSBL	\$3,499.00
---------------------------------------	---------	------------

JUNIOR HACK ATTACK PITCHING MACHINE



The Junior Hack Attack Baseball Pitching Machine is the major-league quality training tool designed to develop serious young players.

FEATURES:

- Great for all levels of baseball or softball.
- Throws fastballs, curves, sliders, split fingers and Knuckleballs.
- Pivots instantly for pop-ups, flyballs, grounders and catcher's pop-ups.

Junior Hack Attack Baseball Pitching Machine	BHAJRBB	\$2,599.00
Junior Hack Attack Softball Pitching Machine	BHAJRSB	\$2,599.00

FOUL POLES

20' TWO-PIECE DESIGN FOUL POLES

★ **BEST SELLER!**

Complies with NCAA Rule 2.12 for Softball Foul Poles.

Heavy-duty foul pole constructed of 3.5" OD powder-coated steel. Expanded metal wing panels are 1^{1/2}' x 12'. 24' poles are placed 4' into the ground. Optional galvanized steel ground sleeves available.

White 20' Two-Piece Design Foul Pole	BFPOLE20CW	\$1,859.00
Yellow 20' Two-Piece Design Foul Pole	BFPOLE20C	\$1,859.00
4' Ground Sleeve	BFPSLVE20	\$348.19



20' WHITE



20' YELLOW



4' GROUND SLEEVE

CUSTOM FOUL POLE BANNERS

Spruce up your field with custom foul pole banners designed to fit your existing foul pole wings. Sold in 14 oz promesh windscreens with full graphics included.

SOLD IN PAIRS.

Size: 18" x 12'

Foul Pole Banners (Pair)	BFLBANNER	\$408.62
--------------------------	-----------	----------

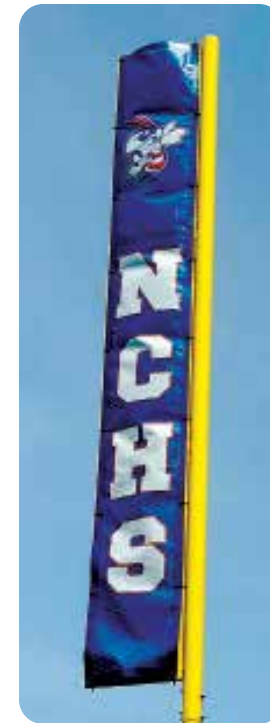

FIELD BANNERS



- Outfield distance markers and other field banners are printed digitally with 14 oz. reinforced vinyl fabric.
- Available with numerals and background colors of your choice.
- Specify distances when ordering!

56" H x 20" L (12" Numerals)	BVDB12	\$128.70
27" H x 36" L (14" Numerals)	BVDB14	\$142.29
38" H x 56" L (24" Numerals)	BVDB24	\$198.16

HALO KITS



Turf halo kits are used on baseball and softball fields, to outline the area behind home-plate. A top-of-the-line protective halo kit will keep this area from being worn out from foot traffic and save money on grass maintenance. Halo kits are also an interesting way to display logos, team or event names, sponsors or memorials.

FEATURES:

- High-grade, spike resistant durable turf
- Designed to fit 36" diameter home plate areas
- Available in 5' or 10' widths and come with unitary (without shock pads) or 5mm foam backing for shock absorption.
- Extension wings available in 5' or 10' lengths.
- Available in standard green or a variety of other colors.
- All custom artwork is inlaid with colored turf.

Halos require a concrete or asphalt slab that should cure for no less than 2 weeks prior to installation



KIT	NO WINGS	WINGS	MRSP
5' Home Plate Halo Kit	BTHALO5	BTHALO5W	\$7,967.96
5' Home Plate Halo Kit & Padding	BTHALO5F	BTHALO5FW	\$10,339.99
10' Home Plate Halo Kit	BTHALO10	BTHALO10W	\$8,988.58
10' Home Plate Halo Kit & Padding	BTHALO10F	BTHALO10FW	\$11,031.43
Solid Color Lettering - 5' Halo	BTHCOL5		\$809.31
Solid Color Lettering - 10' Halo	BTHCOL10		\$858.00
Two-Color Lettering - 5' Halo	BTHLT5		\$0
Two-Color Lettering - 10' Halo	BTHLT10		\$0

TURF CLAW FB TURF ADHESIVE



Turf Claw FB is solvent-free, low odor and designed for the permanent installation of rubber backed and urethane backed carpets, underlayment and flooring.

Four-Gallon Bucket, Turf Claw FB Turf Adhesive	BTADH	\$275.78
--	-------	----------

OXYTURF CLEANER & DISINFECTANT



A one-step, non-acid, ready-to-use, non-abrasive, synthetic turf cleaner & disinfectant. Removes grease & grime. Kills 99.9% of germs, viruses, & bacteria. Patented stabilized Hydrogen Peroxide Technology. Oxygenated cleaning & deodorizing. Good for 4+ years of shelf life.

55 GALLONS WILL CLEAN A WHOLE FOOTBALL FIELD!

One-Gallon Jug with Battery Powered Sprayer	TCOT001BPS	\$69.95
Six Gallon Pail	TCOT006	\$327.95
55-Gallon Drum	TCOT0055	\$1,667.95

PRO TURF MATS



Looking to step up your game with some Pro Turf? Look no further than Trigon Sports. We offer a range of bat mats to suit your needs, including home plate mats, on-deck circles and batter's box mats. Or, if you need Pro Turf for pitchers, check out our pitcher's mats. To fill a larger space, there's turf by the roll as well.

All Pro Turf mats are constructed of top quality spike-proof turf with a 5mm shock absorbing cushion.

TURF ON DECK CIRCLES



Made of spike-proof turf with a 5mm shock absorbing cushion, our top-of-the-line on-deck circles give the upcoming batter their specific space to warm up. Mats can be customized with team logos or sponsors to help your team and field look and play like the pros.

Available in a variety of colors, or you can send your custom artwork to sales@trigonsports.com for a quote.



Green 6' Diameter	BTMOD6	\$612.86
Clay 6' Diameter	BTMOD6CL	\$612.86
Green 4' Diameter	BTMOD4	\$446.16
Clay 4' Diameter	BTMOD4C	\$446.16
Custom Color 6' Diameter	BTMOD4CC	\$450.45
Custom Color 6' Diameter	BTMOD6CC	\$747.69

PRO-DECK DIGITAL PRINT ON DECK CIRCLES



Constructed using an all-weather memory foam and super thick spike resistant PVC surface.

60" Pro-Deck Circle	PDODC60	\$1,798.23
---------------------	---------	------------

HOME PLATE MATS

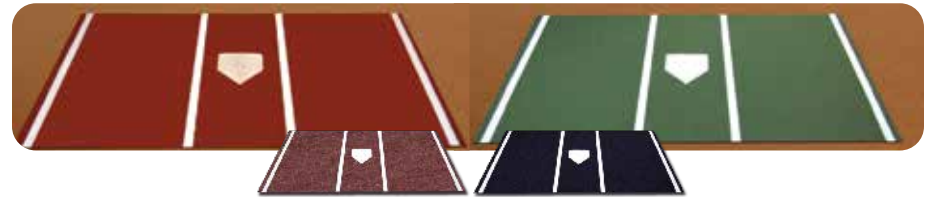

PRO'S CHOICE

Give pitchers a clear reference with a turf home plate mat. Protect your batters box and home plate area. Available in a variety of colors to customize your practice space.

6'x12' Green Home Plate Mat	BTM612	\$582.00
7'x12' Green Home Plate Mat	BTM712	\$704.78
6'x12' Clay Home Plate Mat	BTM612C	\$582.01
7'x12' Clay Home Plate Mat	BTM712C	\$704.78
6'x12' Brown Home Plate Mat	BTM612BR	\$730.73
6'x12' Black Home Plate Mat	BTM612BK	\$730.73

BATTER'S BOX MATS



Protect and prevent digouts quickly and economically with a turf batter's box mat.

4'x6' Baseball Batter's Box Mat	BTMB46	\$286.00
3'x7' Softball Batter's Box Mat	BTMB37	\$255.36
12'x12' Batting Mat - Includes two throw-down home plates	BTBM12	\$1,123.57

PITCHER'S MATS





Prevent time-consuming mound maintenance by covering it with a turf pitching mat during pitching practice.

4'x12' Pitching Mat	BTMP412	\$408.57
6'x12' Pitching Mat	BTMB37	\$255.36

CUSTOM TURF

Pro Turf is perfect for a variety of surfaces including indoor sports facilities, outdoor sports fields, and batting cages and stands up to light steel cleat traffic. The synthetic option offers years of play, low maintenance and performance of the best kept grasses. Urethane and foam backed turf can be glued down for permanent installations on concrete or asphalt. Foam backing gives excellent shock absorbency & durability. Our proven synthetic turf surfaces are ideal for indoor and outdoor soccer fields, football fields, baseball fields, multi-purpose fields, lacrosse, and more!

MINIMUM ORDER OF 180 SQUARE FEET (15' X 12'). COLORS & STYLES MAY VARY

TURF STYLE	ITEM #	FACE WEIGHT	PILE HEIGHT	WIDTH	BACKING	SUGGESTED USE	MRSP
	BTPL357U	24 oz.	1/4"	15'	Urethane	Medium-use turf. Withstands light steel cleat traffic.	\$3.15
	BTPL3575	24 oz.	1/4"	15'	5mm Foam		\$5.01
	BTPL3573	24 oz.	1/4"	15'	3mm Foam	MOST POPULAR TURF FOR INDOOR FACILITIES	\$4.43 sqft
	BTPL705U	36 oz.	9/16"	15'	Urethane	MOST POPULAR TURF FOR OUTDOOR BATTING CAGES High quality, durable turf. Ideal for batting cages, bullpens & dugouts. Withstands steel cleats.	\$4.28
	BTPL7055	36 oz.	9/16"	15'	5mm Foam		\$5.96
	BTAT740U	40 oz.	3/4"	15'	Urethane	Most popular turf for sports fields and arenas. Most durable turf. Stands up to heavy steel cleat traffic.	\$5.13
	BTAT7405	40 oz.	3/4"	15'	5mm Foam		\$6.68

*Turf home plate & pitching mats should be used in high traffic & batting areas to prolong turf life. Actual colors of turf may vary from images above. All turf ships truck freight.

TURF CLAW FB TURF ADHESIVE



Turf Claw FB is solvent-free, low odor and designed for the permanent installation of rubber backed and urethane backed carpets, underlayment and flooring.

Four-Gallon Bucket, Turf Claw FB Turf Adhesive	BTADH	\$275.78
--	-------	----------

OXYTURF CLEANER & DISINFECTANT



A one-step, non-acid, ready-to-use, non-abrasive, synthetic turf cleaner & disinfectant. Removes grease & grime. Kills 99.9% of germs, viruses, & bacteria. Patented stabilized Hydrogen Peroxide Technology. Oxygenated cleaning & deodorizing. Good for 4+ years of shelf life.

55 GALLONS WILL CLEAN A WHOLE FOOTBALL FIELD!

One-Gallon Jug with Battery Powered Sprayer	TCOT001BPS	\$69.95
Six Gallon Pail	TCOT006	\$327.95
55-Gallon Drum	TCOT0055	\$1,667.95



PORTABLE PITCHER'S MOUNDS



PREP GAME MOUND



FEATURES:

- Size: 9'L x 4'W x 6"H
- Spike-proof artificial turf with 1-Year limited warranty
- Non-slip, non-marking, rubber backing
- Lightweight, portable, high strength construction
- Shock absorbing landing area
- For pitching distances of 54' or less

Green Prep Game Mound	B417000	\$1,555.00
Clay Prep Game Mound	B418000	\$1,555.00

TAPERED PREP MOUND



FEATURES:

- Size: 9'L x 4'W x 6"H
- Spike-proof artificial turf with 1-Year limited warranty
- Non-slip, non-marking, rubber backing
- Lightweight, portable, high-strength construction
- Shock absorbing landing area
- For pitching distances of 54' or less
- Tapered sides allow pitcher's to throw to all bases

Green Tapered Prep Mound	B817000TG	\$1,709.00
Clay Tapered Prep Mound	B818000TC	\$1,709.00

COLLEGIATE PREP PITCHER'S MOUND

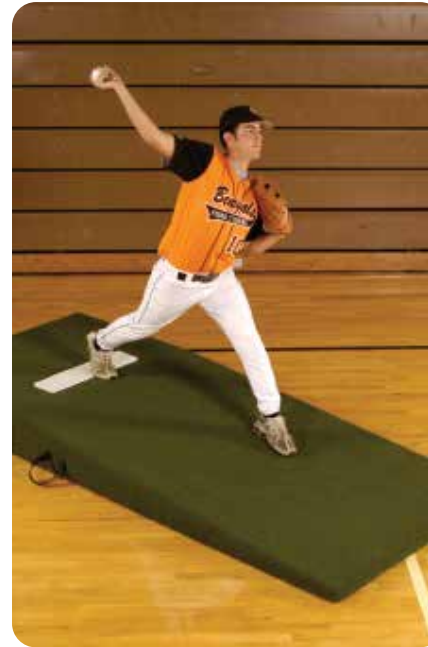

FEATURES:

- Size: 9'6"L x 4'W x 10"H
- Spike-proof artificial turf with 1-Year limited warranty
- Non-slip, non-marking, rubber backing
- Lightweight, portable, high strength construction
- Shock absorbing landing area

Green Collegiate Prep Mound	B417002	\$1,825.00
Clay Collegiate Prep Mound	B418002	\$1,919.00

PRO PRACTICE PITCHER'S MOUND



FEATURES:

- Size: 9'6"L x 5'4"W x 10"H
- Spike-proof artificial turf with 1-Year limited warranty
- Non-slip, non-marking, rubber backing
- Lightweight, portable, high strength construction
- Shock absorbing landing area

Green Pro Practice Mound	B417003	\$1,964.00
Clay Pro Practice Mound	B418003	\$1,964.00

ALL MOUNDS SHIP FREIGHT.

PORTABLE PITCHER'S MOUNDS



JUNIOR GAME MOUND



FEATURES:

- **Size:** 9'L x 5'4"W x 6"H
- Spike-proof artificial turf with 1-Year limited warranty
- Non-slip, non-marking, rubber backing
- Lightweight, portable, high strength construction
- Shock absorbing landing area
- For pitching distances of 54' or less

Green Junior Game Mound	B417001	\$2,156.00
Clay Junior Game Mound	B418001	\$2,156.00

TAPERED JUNIOR GAME MOUND



FEATURES:

- **Size:** 9'L x 5'4"W x 6"H
- Spike-proof artificial turf with 1-Year limited warranty
- Non-slip, non-marking, rubber backing
- Lightweight, portable, high strength construction
- Shock absorbing landing area
- For pitching distances of 54' or less
- Tapered sides allow pitchers to throw to all bases

Green Junior Game Mound	B817001TG	\$2,387.00
Clay Junior Game Mound	B818001TC	\$2,387.00

PRO PITCHER'S GAME MOUND



FEATURES:

- **Size:** 11'6"L x 8'3"W
- Spike-proof artificial turf with 1-Year limited warranty
- Non-slip, non-marking, rubber backing
- Lightweight, portable, high strength construction
- Shock absorbing landing area
- For pitching distances of 60'6"

Green 8" Pro Game Mound	B817004	\$3,196.00
Clay 8" Pro Game Mound	B818004	\$3,196.00
Green 10" Pro Game Mound	B417004	\$3,119.00
Clay 10" Pro Game Mound	B418004	\$3,119.00

TAPERED PRO GAME MOUND



FEATURES:

- **Size:** 11'6"L x 8'3"W
- Spike-proof artificial turf with 1-Year limited warranty
- Non-slip, non-marking, rubber backing
- Lightweight, portable, high strength construction
- Tapered sides allow pitchers to throw to all bases

Green 8" Tapered Pro Game Mound	B807004	\$3,768.75
Clay 8" Tapered Pro Game Mound	B808004	\$3,768.75
Green 10" Tapered Pro Game Mound	B107004	\$3,678.75
Clay 10" Tapered Pro Game Mound	B108004	\$3,678.75

ALL MOUNDS SHIP FREIGHT.

BATTING PRACTICE PITCHING PLATFORM



FEATURES:

- **Size:** 7'L x 4"W
- Spike-proof artificial turf with 1-Year limited warranty
- Lightweight, portable, high strength construction
- Shock absorbing landing area
- Wheels for easy transportation on & off field

Batting Practice Pitching Platform	B417016	\$1,440.00
------------------------------------	---------	------------

PONY PITCHING MOUND



FEATURES:

- **Size:** 54"L x 49"W x 6"H
- Weighs 50 lbs.
- Easy to move & store
- Fully turfed with regulation pitching rubber
- Tapered sides allow pitchers to throw to first and third base

Green Pony Pitching Mound	B417020	\$1,155.00
Clay Pony Pitching Mound	B418020	\$1,155.00

JUNIOR TRAINING PITCHING MOUND



FEATURES:

- **Size:** 42"L x 42"W x 4"H
- Great for working on mechanics & pickoffs
- Portable, lightweight design for transport anywhere

Green Junior Training Mound	B419005	\$847.00
Clay Junior Training Mound	B419006	\$847.00

2-PIECE INDOOR PITCHING MOUND



FEATURES:

- **Size:** Collegiate - 9'6"L x 4"W x 10"H
Pro - 9'6"L x 5'4"W x 10"H
- Two-piece design for easy moving & storage
- Interlocking sections allow bottom piece to be offset
- Will not damage or scratch gym floors

Green Collegiate 2-Piece Mound	B417030	\$1,925.00
Clay Collegiate 2-Piece Mound	B418030	\$1,925.00
Green Pro 2-Piece Mound	B417032	\$2,110.00
Clay Pro 2-Piece Mound	B418032	\$2,110.00

ALL MOUNDS SHIP FREIGHT.

PORTABLE PITCHER'S MOUNDS



JUNIOR PRO MOUND



FEATURES:

- Size: 6'L x 42"W x 6"H
- Great for working on mechanics & pickoffs
- Portable, lightweight design for transport anywhere

Green Junior Pro Mound	B419002	\$1,309.00
Clay Junior Pro Mound	B419003	\$1,309.00

TAPERED JUNIOR PRO MOUND



FEATURES:

- Size: 6'L x 42"W x 6"H
- Great for working on mechanics & pickoffs
- Portable, lightweight design for transport anywhere

Green Tapered Junior Pro Mound	B819002TG	\$1,448.00
Clay Tapered Junior Pro Mound	B819003TC	\$1,448.00

FOLD 'N' ROLL MOUND



FEATURES:

- Size: Collegiate - 9'6"L x 4'W x 10"H
Pro - 9'6"L x 5'4"W x 10"H
- Lightweight, portable design with spike-proof artificial turf
- Non-slip, non-marking, rubber backing
- Regulation slope for learning proper mechanics
- Folds up & rolls away in seconds

Green Collegiate Fold 'n' Roll Mound	B417002F	\$1,887.00
Clay Collegiate Fold 'n' Roll Mound	B418002F	\$1,887.00
Green Pro Fold 'n' Roll Mound	B417003F	\$2,041.00
Clay Collegiate Fold 'n' Roll Mound	B418003F	\$2,041.00

SOFTBALL PITCHING MATS



FEATURES:

- Sizes: 3'W x 10'L & 3' x 3'
- Spike-proof artificial turf
- Non-slip, non-marking, rubber backing
- Permanent pitching rubber

3' x 3' Mini Pitching Mat	B417026	\$153.37
3' x 10' Pitching Mat with Stride Line	B417010	\$306.42
3'x10' Pitching Mat without Stride Line	SBPM310	\$306.45

ALL MOUNDS SHIP FREIGHT.

HOME PLATES & PITCHING RUBBERS

MAJOR LEAGUE HOME PLATE

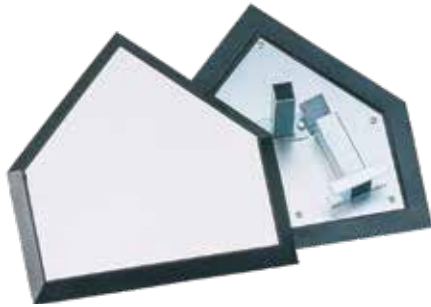

Professional anchor-style home plate. Includes ground anchor.

Major League Home Plate	BHPML	\$127.97
-------------------------	-------	----------

MOLDED RUBBER HOME PLATE



Professional anchor-style home plate. Includes ground anchor.

Molded Rubber Home Plate	BHPMR	\$92.94
--------------------------	-------	---------

LOW PROFILE HOME PLATE

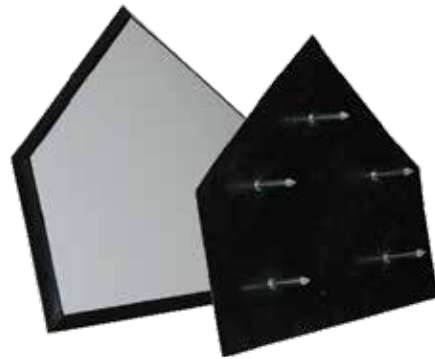

Low-profile home plate sold with ground spikes for in-ground system. Includes ground spikes.

Low Profile Home Plate	BHPSL	\$49.32
------------------------	-------	---------

WAFFLE BOTTOM HOME PLATE

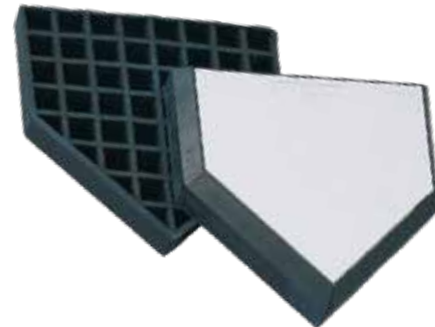

Professional bury-all home plate with waffle bottom.

Waffle Bottom Home Plate	BWBHP	\$122.97
--------------------------	-------	----------

WOOD BOTTOM HOME PLATE

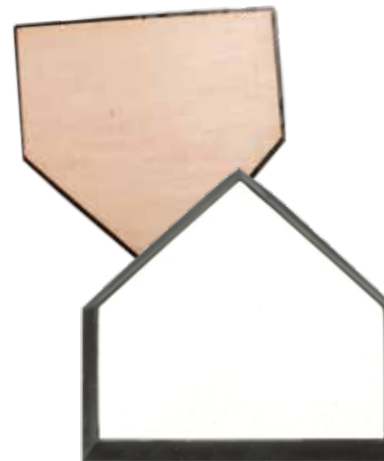

Solid wood filling with beveled outer edge.

Wood Bottom Home Plate	BHPWD	\$122.97
------------------------	-------	----------

THROW DOWN HOME PLATE



Heavy-duty rubber home plate with waffle bottom and beveled edges.

Throw Down Home Plate	BDHPW	\$36.45
-----------------------	-------	---------

STRIKE ZONE HOME PLATE



Heavy-duty rubber home plate with painted strike zones.

Strike Zone Home Plate	BSTRKHP	\$21.45
------------------------	---------	---------

THROW DOWN CLEAT CLEANER

PRO'S CHOICE

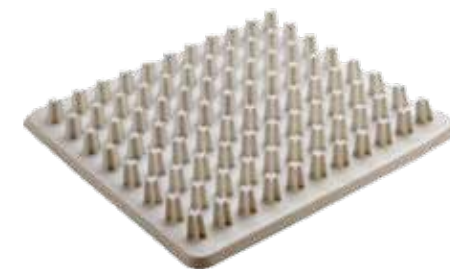

Features 88 tough rubber bristles that quickly & easily remove dirt & debris from cleats. Holes in each corner for stake-down option.

12" x 11" Throw Down Cleat Cleaner	BHDRCC	\$34.32
------------------------------------	--------	---------

HOME PLATES & PITCHING RUBBERS

STEP DOWN PITCHING RUBBER



Official size with solid wooden core and molded rubber cover.

6" x 24" Step Down Pitching Rubber	BPPSD	\$93.65
4" x 18" Youth Step Down Pitching Rubber	BPPSDJ	\$71.49

4-WAY PITCHING RUBBERS



Heavy-duty rubber with a hard inner support tube. Pitching rubber can be rotated for use on all four sides.

6" x 24" 4-Way Pitching Rubber	BPP4W	\$122.97
4" x 18" Youth 4-Way Pitching Rubber	BPP4WJ	\$80.78

IN-GROUND ANCHOR POST



Removable in-ground anchor system for pitching plate.

PITCHING PLATE SOLD SEPARATELY!

Official Size In-Ground Anchor	BIGPPAP	\$39.31
Youth In-Ground Anchor Post	BIGPPAPJ	\$49.32



Pitcher's plate sold with ground spikes for in-ground system.

PITCHER'S PLATE & ANCHOR SYSTEM SOLD SEPARATELY!

6" x 24" Pitching Plate	BIGPP	\$41.46
4" x 18" Youth Pitching Plate	BIGPPJ	\$22.15

BASE SETS

HOLLYWOOD STYLE BASE SET

★ **BEST SELLER!**



Hollywood style professional anchored 3-base set.

SET INCLUDES:

- 3 Bases
- 3 Anchors
- 3 Plugs

Hollywood Style Base Set	BMLBS	\$245.95
--------------------------	-------	----------

18" PRO MAJOR LEAGUE BASE SET



18" Professional Major league style anchored 3-base set.

SET INCLUDES:

- 3 Bases
- 3 Anchors
- 3 Plugs

18" PRO Major League Base Set	BMLBS18	\$376.75
-------------------------------	---------	----------

BASE SETS

MOLDED RUBBER BASE SET

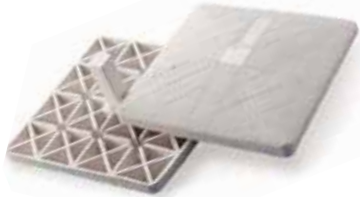

15" x 15" x 2" molded rubber bases.

SET INCLUDES:

- 3 Bases
- 3 Anchors
- 3 Plugs

Molded Rubber Base Set	BMRBS	\$260.25
------------------------	-------	----------

MAGNETIC BREAK-FREE BASE



Each base includes molded rubber cover, stanchion, ground anchor with magnetic fixture and three galvanized steel plates for different resistance.

PRICED AND SOLD PER BASE!

Magnetic Break-Free Base	BBMAG	\$295.28
--------------------------	-------	----------

GROUND ANCHORS

1 1/2" (Female opening) x 8" long. For all bases & plates that utilize a 1 1/2" anchor system. Sold in Sets of 3.



Ground Anchors (Set of 3)	BMLANCH	\$44.32
---------------------------	---------	---------

PRO DOUBLE FIRST BASE



MEETS COLLEGIATE ATHLETIC SPECIFICATIONS

Professional Double First Base features one-piece molded rubber construction. Comes complete with ground anchors and plugs.

Size: 30" x 15" x 2.5"

Pro Double First Base	BDFBML	\$228.79
-----------------------	--------	----------

THROW DOWN BASE SET



Heavy-duty rubber bases with a waffle bottom and beveled edges. Set includes 3 bases.

Throw Down Base Set	BWBBS	
---------------------	-------	--

DIGOUT TOOL



Features steel construction with wooden handle. Easily cleans dirt from ground anchors.

Digout Tool	BDOUT	\$19.29
-------------	-------	---------

BASE CADDY



NEW!

Heavy duty transport caddy for 1 set of bases and dig out tool. Constructed of all steel components and no flat wheels. Will be able to transport bases up to 18" square that use square hollow stem. Bases not included.

Base Caddy	BBCAD	\$336.05
------------	-------	----------

FLAT RUBBER THROW DOWN BASE SET



Durable flat rubber base set. Set includes 3 bases, pitching rubber and home plate.

Flat Rubber Throw Down Base Set	BTDSO	\$000.00
---------------------------------	-------	----------

FEATHERED BASE PLUGS



Big league base plugs fit snug to keep dirt & debris out of your base anchors. Feathered design allows drags to be pulled directly over plugs without damage.

Feathered Base Plugs (Set of 4)	BFPLUGN	\$37.75
---------------------------------	---------	---------

RUBBER BASE PLUGS

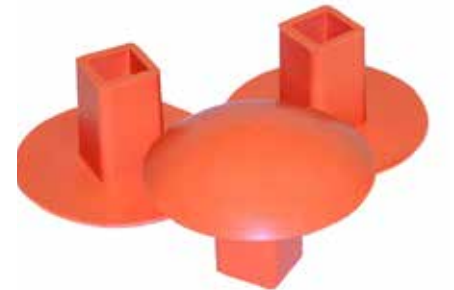

Rubber base plugs fit snug to keep dirt & debris out of your base anchors.

PRICED AND SOLD PER PLUG!

Rubber Base Plug	BDPLUG	\$10.00
------------------	--------	---------

DIRT PRODUCTS

SOLD IN PALLET QUANTITIES ONLY

MOUND CLAY



High-density red clay material used in high wear areas on the mound (toe and landing areas) or in the batter's boxes. Screened at 1/2" to remove debris and "sift" the material. Available in 50 lb. bags or bulk. Please call for bulk pricing.

Mound Clay	MCLAY	\$22.17
------------	-------	---------

ATHLETIC FIELD SURE DRY



Calcined clay material native to the North Mississippi area. Absorbs moisture and helps reduce slick spots on the mound, plate areas or around the bases. Available in 50 lb. bags or bulk. Please call for bulk pricing.

Sure Dry	SUREDRIY	\$22.17
----------	----------	---------

ALL PRO PLUS CHALK



High-quality marble dust for marking athletic fields. Complies with the "Safe Use" requirements of the Consumer Safety Act and NCAA rules for athletic marking materials. Available in 50 lb. bags.

All Pro Plus Chalk	CHALK	\$21.09
--------------------	-------	---------



FIELD CONDITIONERS

FIELD CONDITIONER APPLICATION FOR SKINNED AREAS

FIELD SIZE	INFIELD TYPE	QUANTITY
Baseball		
95 Foot Radius	Grass Infield Only	40-80 Bags
95 Foot Radius	Grass Infield (6' Baseline)	60-80 Bags
Softball		
65 Foot Radius	Skinned w/ Grass Apron	40-80 Bags
65 Foot Radius	All Skinned	80-120 Bags
Youth		
50 Foot Radius	Grass Infield Only	40 Bags
50 Foot Radius	Grass Infield - 4' Baseline	50 Bags
50 Foot Radius	All Skinned	80-120 Bags

Field conditioner absorbs excess moisture to keep field consistently playable. Field conditioners can be used to help reduce compaction in high traffic areas in your turf grass or as a top dressing material for your football, soccer, and outfield turf grass. Available in two particle sizes, 516 and 816. Available in 50 lb. bags or bulk.

Mule Mix 516 Conditioner	MULE516	\$18.96
Mule Mix 816 Conditioner	MULE816	\$22.52

PUDDLE PILLOW



Remove small puddles on your field quickly. Place pillows in standing water and when pillows are saturated, squeeze out absorbed water. Can be reused multiple times! 10 pillows per case. Each pillow can absorb up to 3.5 liters of water.

Puddle Pillow	PILLOW	\$120.12
---------------	--------	----------

COMPARE TO SURFACE MVP 516



COMPARE TO SURFACE ELITE 816

FIELD MAINTENANCE

PRO FIELD RAKE

★ BEST SELLER!



All aluminum construction designed for institutional use. Durable and lightweight with oversized teeth. Use one side to rake and the other side to level.

24" Head-width Pro Field Rake	BRAKE24	\$75.78
36" Head-width Pro Field Rake	BRAKE36	\$87.93
48" Head-width Pro Field Rake	BRAKE48	\$100.80

DUAL PURPOSE RAKE



Features two teeth designs. Short teeth for breaking up hard clay, while the long teeth are for wet clay and general raking. 66" powder-coated aluminum handle with 6" non-slip vinyl grip provides extra comfort.

24" Head-width Dual Purpose Rake	BRAKE24DP	\$102.96
36" Head-width Dual Purpose Rake	BRAKE36DP	\$120.86

PRO TURF LUTE RAKE



Lightweight design is perfect for spreading dirt, gravel or for grading soil. Comes with 82" powder-coated aluminum handle in 24" or 36" head widths.

24" Head-width Pro Turf Lute Rake	BRAKELT24	\$84.51
36" Head-width Pro Turf Lute Rake	BRAKELT36	\$94.98

INFIELD LIP BROOM



Heavy-duty 28" head with scarifying edge and two rows of removable bristles. Powder-coated aluminum handle is bent to reduce back strain.

Infield Lip Broom	BLPBROOM	\$164.95
-------------------	-----------------	-----------------

7' DOUBLE PLAY MONSTER DRAG BROOM



7' head with A-frame padded handle with hooks for hanging. Short teeth for breaking up hard, dry clay.

2 Rows of Bristles w/ Scarifying Teeth	BMBROOM2	\$358.74
3 Rows of Bristles	BMBROOM3	\$321.75

COCOA/MOUND MOP



High-quality 1" thick cocoa material with a heavy-duty vinyl backing. Excellent for mounds and areas that require tight maneuvering.

24" x 16" Cocoa Mound Mop	BCMOP24	\$189.10
---------------------------	----------------	-----------------

FIELD MAINTENANCE

STEEL FLEX DRAG MOP



Designed to finish grooming small areas. Powder-coated aluminum handle is 66" long with aluminum head and wrap around bracing.

24" x 18" Steel Flex Drag Mop	BSFDM	170.16
-------------------------------	-------	--------

FINISHER MOP

NEW!



All rubber finishing mop for mounds and other areas that require tight maneuvering.

24" x 18" Finisher Mop	BFINMOP	\$175.89
------------------------	---------	----------

NON-ABSORBENT ROLLER SQUEEGEE



36" head with 60" aluminum handle. Great for pushing water off of hard surfaces.

Roller Squeegee	TNRLR36	\$224.25
Replacement Roller	TNRLR36R	\$98.63

DIRT TAMP



Designed for rugged use. No more broken handles with our solid welded steel construction. 48" Handle with 12" solid vinyl grip.

Dirt Tamp	BTAMP10	\$113.67
-----------	---------	----------

LOOP HOE



Double knife edge rocks back and forth with a push/pull motion. Fiberglass handle.

Loop Hoe	BLPHOE	\$54.83
----------	--------	---------

SIFTING SCOOP



Designed to finish grooming small areas. Powder-coated aluminum handle is 66" long with aluminum head and wrap around bracing.

14" x 17" Sifting Scoop	SSCOOP	\$156.93
-------------------------	--------	----------

DRAG MATS

ALL STEEL DRAG MATS



All steel drag mats come complete with drag bar and rope with handle. Perfect for grooming and general field maintenance.

3'W x 5'L Drag Mat	BDMAT35	\$181.60
6'W x 3'L Drag Mat	BDMAT63	\$263.11
6'W x 6'L Drag Mat	BDMAT66	\$392.52

MONSTER DRAG MATS



Deluxe mat construction utilizes 1/2" x .062 mesh with 6 gauge connecting rods, each welded on end. Includes angle iron front with welded eye bolts for you to attach your chain. Mat cannot separate & will last for years!

6'W x 4'L Drag Mat	BDMATM64	\$544.82
9' Drag Chain	CHAIN	\$56.63

RIGID DRAG MATS

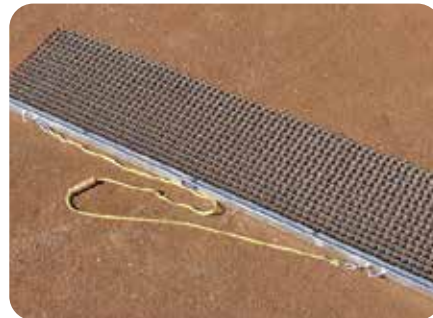

1" x 1" mesh, 13 gauge galvanized connecting rods. Mesh is rotated 90 degrees to make mat rigid. Rigid mats **can NOT** be rolled up for storage.

4'W x 18"L Rigid Drag Mat	BDMR418	\$181.6
6'W x 18"L Rigid Drag Mat	BDMR618	\$226.64

STEEL BOLT DRAG



Utilizes 46 staggered heavy grade bolts for heavy dragging. Includes pull chain that can be adjusted by moving to other pre-drilled holes. Additional weight can be added with cement blocks (not included).

Size: 6' x 17"

Steel Bolt Drag	BDRAGDR	\$454.01
Replacement Bolts (Set of 46)	BDBOLTS	\$181.60S

FINISHER MAT

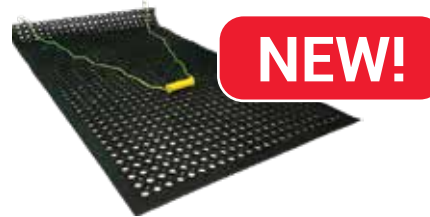

NEW!

All rubber 'finisher' drag mat provides a great alternative to steel drag mats or to use in conjunction with your steel drag for a smooth surface. Quick drag down your base paths. Mat includes steel front drag bar and tow rope with handle. Easily rolls for transport and storage.

3'x5' Finisher Mat	FINMAT35	\$135.85
5'x3' Finisher Mat	FINMAT53	\$141.57
6'x3' Finisher Mat	FINMAT63	\$178.75
6'x6' Finisher Mat	FINMAT66	\$314.60

6' WIDE LEVELING BAR



Cuts out high spots and allows attached drag mat to redistribute and level infield playing surface.

6' Wide Leveling Bar	BLVLBAR	\$158.72
----------------------	---------	----------

COCOA DRAG MATS



Features a 1" thick natural fiber surface with a heavy duty rubber backing. Perfect for smoothing out the playing surface after a heavy drag or between innings. Includes drag bar and pull rope with plastic handle. Drag bar can be moved to either side of mat to prolong use. Holes are self-drilled to allow for preferred placement of drag bar.

4'W x 2'L Cocoa Drag Mat	BCMAT42	\$244.79
6'W x 2'L Cocoa Drag Mat	BCMAT62	\$293.69
6'W x 4'L Cocoa Drag Mat	BCMAT64	\$489.49
9' Drag Chain	CHAIN	\$56.63

DRY LINE MARKERS

PROCAGE™ 100 LB CAPACITY DRY LINE MARKER



- Galvanized steel with green powder-coated finish.
- Galvanized steel axle and dispensing wheel.
- White guide strip on lid for proper alignment.
- 4 Heavy-duty no-flat turf tires.
- Hand lever is adjustable for 2" or 4" chalk lines.

100 Lb. Capacity Dry Line Marker	BDLM100	\$403.25
----------------------------------	---------	----------

PROCAGE™ 35 LB CAPACITY DRY LINE MARKER



- Galvanized steel with green powder-coated finish.
- Galvanized steel axle and dispensing wheel.
- White guide strip on lid for proper alignment.
- 2 Heavy-duty hard wheels.
- Hand lever is adjustable for 2" or 4" chalk lines.

35 Lb. Capacity Dry Line Marker	BDLM35	\$195.90
---------------------------------	--------	----------

PROCAGE™ 50 LB CAPACITY DRY LINE MARKER



- Galvanized steel with green powder-coated finish.
- Galvanized steel axle and dispensing wheel.
- White guide strip on lid for proper alignment.
- Available with heavy-duty no-flat turf tires or heavy-duty hard wheels.
- Hand lever is adjustable for 2" or 4" chalk lines.

50 Lb. Capacity Dry Line Marker	BDLM50P	\$360.35
50 Lb. Capacity Dry Line Marker (Hard Wheels)	BDLM50	\$258.82

FOLDABLE BATTER'S BOX TEMPLATE



This aluminum template has a light-weight design that is foldable for easy transport & storage. Simply align handle with home plate & press down on template to leave 2" pattern for chalking.

4'x6' Foldable Template	BFTMP46	\$260.96
3'x6' Foldable Template	BFTMP36	\$260.96
3'x7' Foldable Template	BFTMP37	\$260.96



BATTER'S BOX TEMPLATE



Heavy-duty 1" square galvanized steel construction features a home plate guide for easy alignment. Available in 4'x6' (baseball), 3'x7' (softball) and 3-way adjustable (4'x6', 3'x6', 3'x7').

4'x6' Baseball Template	BTMPL46	\$204.48
3'x7' Softball Template	BTMPL37	\$204.48
3-Way Adjustable Template	BTMPLA	\$272.40



FOR CHALK
SEE PAGE 28

FIELD MARKING

ATHLETIC FIELD STRIPERS



Fold-up handle. Features four large heavy-duty wheels. Adjustable 2"-4" stripe. Has storage for 12 extra cans of paint. Ideal for grass and dirt fields.

Standard Model (right):

- Four heavy-duty 10" wheels NEW Deluxe Model (left) :
- Four large pneumatic style no-flat wheels

Athletic Field Striper	BLMSTRIFE	\$227.37
Deluxe Athletic Field Striper	BLINERX	\$321.75

AEROSOL FIELD PAINT



Fast-drying, water resistant. Universal tip fits most machines. 12 (20oz.) cans per case. Available in white, red, yellow, purple, royal, navy, black, orange, maroon, turf green, brown, silver, pink & gold.

White Aerosol Field Paint	LINEW	\$91.83
Color Aerosol Field Paint	LINEC	\$94.00

STRING WINDERS



String line retrieval and storage device complete with 500' of #36 heavy nylon string. Winder makes field lining a breeze & ensures straight lines!

Deluxe Model Features:

- String line retrieval
- Storage device
- 500' of #36 heavy nylon string
- Handle
- Two stakes
- Stand

Standard String Winder	BSTRING	\$52.85
Deluxe String Winder	BDSTNG	\$73.70

PROLINE BASEBALL FIELD LAYOUT SYSTEM

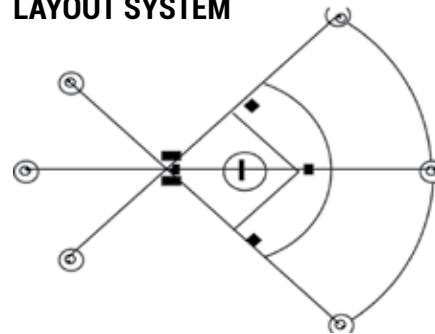

Quickly mark any size baseball field. Measure once and easily restripe year after year. Includes 6 sockets, white plugs and 600' of cord.

Proline Baseball/ Softball Field Layout System	BLS12	243.10
--	-------	--------

PROLINE LACROSSE FIELD LAYOUT SYSTEM

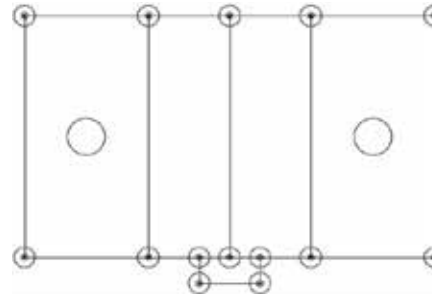

Quickly and easily layout your lacrosse field with this easy to use kit. Measure once and easily restripe year after year. Includes 14 sockets, starter tool & 600' of twine.

Proline Lacrosse Field Layout System	LLS14	\$140.45
--------------------------------------	-------	----------

PROLINE SOCCER FIELD LAYOUT SYSTEM

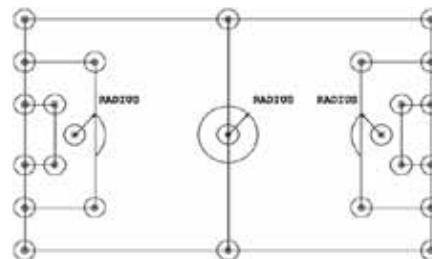

Quickly Mark any size soccer field. Measure once and restripe year after year. Includes 25 locators, starting tool and 600' cord.

Proline Soccer Field Layout System	SLS25	\$337.48
------------------------------------	-------	----------

PROLINE FOOTBALL FIELD LAYOUT SYSTEM

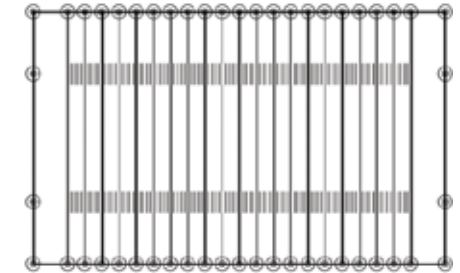

Locate measurements and quickly mark any size football field. If marked lines become too faded to follow for restriping, locators remain in place. Restriping the faded area, and your marked lines are relocated exactly. Additional markers available in 6 and 10-piece sets can be used to locate inbound lines, coaches' boxes and more. All sets include 50 locators, starting tool and 600' roll of cord.

Football Field Layout System	FLS50	\$580.58
------------------------------	-------	----------

IRRIGATION

1" FIELD HOSES



Featuring outstanding durability and performance, Trigon's field hose series offers a wide selection of precision engineered and manufactured hoses. Made from reinforced rubber and synthetic yarns, these hoses provide a variety based on your application and budget.

100' Hose - GREEN	BPFH100	\$426.88
50' Hose - GREEN	BPFH50	\$251.39
100' Hose - CLEAR	BCFH100	\$362.93
50' Hose - CLEAR	BCFH50	\$244.89
50' Hose - RED	BRFH50	\$188.19
75' Hose - RED	BRFH75	\$344.63
100' Hose - RED	BRFH100	\$440.44
150' Hose - RED	BRFH150	\$540.54



DIAMOND PUMP

Great for removing water from any playing surface. Unit pumps 20 gallons per minute and prevents debris from being drawn in. Additional hose sections & replacement parts are available.

Diamond Pump	BDPUMP	\$160.70
--------------	--------	----------

HEAVY DUTY HOSE CARTS



Designed for the Sports Turf Professional. Maximum durability, no flat tires, great leverage to make it easy to bring a hose on and off a field with ease! Shown with optional tool box.

FEATURES:

- Holds Over 100 Feet of 1" Hose or 125 Feet of 3/4" Hose
- Heavy Duty Hand Truck Frame Easily Maneuvers Hose On and Off the Field
- Solid Rubber Wheels Never Go Flat and Heavy Duty Bearings to Ensure Durability
- Quick Coupler Key Holder Keeps Out of the Way and Accessible
- Includes a 10 Foot Ultramax Blue Leader Hose
- Tool Box Available as Optional Add-On
- Available in 1" or 3/4" Hose Versions

Heavy Duty Hose Cart	HOSECART	\$1,313.81
Hose Cart Tool Box	HOSEBOX	\$173.75

PUDDLE PILLOW

Remove small puddles on your field quickly. Place pillows in standing water and when pillows are saturated, squeeze out absorbed water. Can be reused multiple times! 10 pillows per case. Each pillow can absorb up to 3.5 liters of water.

Puddle Pillow	PILLOW	\$120.12
---------------	--------	----------



PUDDLE PILLOW

PRO SPRAY NOZZLES & COUPLERS



UltraMAX nozzles excel in high demand areas like greens/tees, infield conditioning, and equipment/stadium wash downs. All models offer multi-pattern spray: Fog, Jet Stream, Fan

A. 3/4" Variable Flow Nozzle	BPNMAG	\$52.48
B. UltraMAX 1" Economy Plus Nozzle	BPNUPEP	\$59.99
C. UltraMAX 1" Premium Nozzle	BPNUPEP	\$99.10
D. Quick Coupler Valve	BQUICKV	\$95.25
E. Quick Coupler Key	BQUICKKEY	\$85.25
F. Swivel Elbow	BSWIVELB	\$66.50

SUPER SOPPER



Quickly remove standing water from your playing surface. Can be used on grass, tennis courts or artificial turf. Features an outer foam pad that quickly absorbs water and squeezes it into holding tank.

Mackerel Super Sopper (7 Gallon)	MACKEREL	\$1,347.78
Dolphin Super Sopper (14 Gallon)	DOLPHIN	\$1,339.91

TURF/GROWTH COVERS



BASEBALL



FOOTBALL



SOCCER



GOLF

GROWTH COVERS & WINTER TURF BLANKETS

Maintain thicker, greener and healthier grass all year! Made of 3 oz. 100% woven polypropylene, Growth Covers/Winter Turf Blankets, feature a translucent material that allows 90% light to pass through in order to help with optimal grass growth and protection year-round. The border of the covers has a 6-ply, double stitched hem with brass grommets spaced 5' apart.

Includes sod staples. 9" safety yellow stakes available and sold separately

As a winter turf blanket:

- Provides turf protection from harsh winter conditions.
- Shields your turf from wind, ice, snow, and frost.
- Also prevents unwanted foot and animal traffic.

As a growth cover:

- Promotes faster growth and green-up in the spring.
- Retains heat and moisture to naturally warm the soil and air temperature.
- Allows sunlight to pass through the cover.

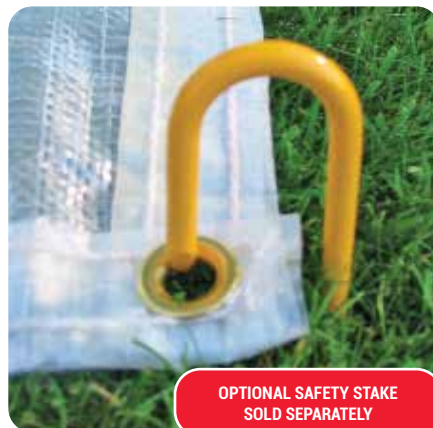

**OPTIONAL SAFETY STAKE
SOLD SEPARATELY**

10'x50' Turf/Growth Cover	GC1050	\$180.18
12'x50' Turf/Growth Cover	GC1250	\$207.35
24'x50' Turf/Growth Cover	GC2450	\$374.66
36'x50' Turf/Growth Cover	GC3650	\$589.16
50'x50' Turf/Growth Cover	GC5050	\$817.96
50'x60' Turf/Growth Cover	GC5060	\$979.55
60'x60' Turf/Growth Cover	GC6060	\$1,176.89
60'x66' Turf/Growth Cover	GC6066	\$1,291.29
60'x75' Turf/Growth Cover	GC6075	\$1,471.47
80'x105' Turf/Growth Cover	GC80105	\$2,742.74
84'x90' Turf/Growth Cover	GC8490	\$2,468.18
84'x110' Turf/Growth Cover	GC84110	\$3,078.79
90'x90' Turf/Growth Cover	GC9090	\$2,644.07
110'x110' Turf/Growth Cover	GC110110	\$3,949.66
Optional 9" Safety Stake	GCSTY9	\$2.42

SPOT COVERS

HEAVY-DUTY SPOT COVERS



**GREEN
IN-STOCK**

CUSTOM SIZES & COLORS AVAILABLE

Heavy-duty covers are constructed of a high grade 18 oz. vinyl. Grommets are spaced 3-4' around perimeter. Ground stakes included.

SIZE	DARK GREEN	MRSP	CUSTOM COLOR	MRSP
Complete Set - (3) 10'x10', (1) 20', (1) 26'	BHSPOTS	\$1,174.77	BHSPOTSC	\$1,771.00
Set of 3 10'x10' Base Covers	BHSPOT10	\$390.39	BHSPOT10C	\$460.46
12' Circular Base Cover	BHSPOT12	\$181.55	BHSPOT12C	\$218.79
18' Circular Mound Cover	BHSPOT18	\$371.80	BHSPOT18C	\$417.56
20' Circular Mound Cover	BHSPOT20	\$447.59	BHSPOT20C	\$497.64
26' Circular Home Plate Cover	BHSPOT26	\$696.41	BHSPOT26C	\$815.10
30' Circular Home Plate Cover	BHSPOT30	\$882.31	BHSPOT30C	\$1,093.95

NEW In Stock Colors: Dark Green, Red, Royal Blue, Navy Blue.



Custom Colors: White, Black, Kelly Green, Grey, Maroon, Purple, Orange, Yellow & Carolina Blue.



LIGHT-DUTY SPOT COVERS



Light-duty covers are constructed of a quality 6 oz. poly. Grommets are spaced 3-4' around perimeter. Ground stakes included.

Complete Set - (3) 10'x10', (1) 20', (1) 26' - 59lbs	BSPOTS	\$491.81
Set of 3 10'x10' Base Covers - 13lbs	BSPOT10	\$126.64
18' Circular Mound Cover - 18lbs	BSPOT18	\$119.09
20' Circular Mound Cover - 22lbs	BSPOT20	\$147.4
26' Circular Home Plate Cover - 24lbs	BSPOT26	\$239.30
30' Circular Home Plate Cover - 30lbs	BSPOT30	\$309.91

WEIGHTED SPOT COVERS



Available in a high-grade 18 oz. vinyl (13 color options) or a 6 oz. poly (Silver/White). Weighted chain sewn-in hems allows for easier rolling and folding. Covers stay in place without stakes or sandbags.

Custom Colors: White, Dark Green, Red, Black, Royal Blue, Kelly Green, Grey, Navy Blue, Maroon, Purple, Orange, Yellow & Carolina Blue.



SIZE	HD 18 OZ VINYL	MRSP
10'x10' Square	BHVYCV10	\$423.28
12' Circular	BHVYCV12	\$599.17
18' Circular	BHVYCV18	\$885.17
20' Circular	BHVYCV20	\$1,041.04
26' Circular	BHVYCV26	\$1,480.05
30' Circular	BHVYCV30	\$1,851.85

SIZE	6 OZ POLY (silver/white)	MRSP
10'x10' Square	BLTCV10 (3 PIECE SET)	\$858.00
12' Circular	BLTCV12	\$380.38
18' Circular	BLTCV18	\$619.19
20' Circular	BLTCV20	\$707.85
26' Circular	BLTCV26	\$975.26
30' Circular	BLTCV30	\$1,144.00

FIELD COVERS & STORAGE

FULL FIELD COVERS



3-Year Warranty! Made from 7 oz. high-strength, long-lasting, reinforced PVC and polyethylene fabrics. Double-stitched on all four sides with brass grommets placed evenly around the perimeter every 10'. Cover is fabricated in one piece with welded seams. Reinforced corners and web handles located around perimeter. Our Full Field covers are waterproof and rot resistant.

INCLUDES 50 SANDBAGS! CALL FOR CUSTOM QUOTE!

Color: White/Silver

SIZE	PURPOSE	WEIGHT	ITEM#	MRSP
170' x 170'	Baseball Full Field Cover	1,200 lbs	BTARP170	\$9,724.00
160' x 160'	Baseball Full Field Cover	1,090 lbs	BTARP160	\$9,240.66
120' x 120'	Softball Full Field Cover	615 lbs	BTARP120	\$5,434.00
90' x 90'	Little League Full Field Cover	400 lbs	BTARP90	\$3,058.77

ACCESSORIES	ITEM #	MRSP
(12) 9" Heavy-Duty Anchor Stakes	BTARPAS	\$21.11
(20) Poly Sand Bags 14"x25"	BTARPPSB	\$57.13
Vinyl Sand Bag 9"x20"	BTARPVSB	\$17.09
White Roll Repair Tape 3"x60"	BTARPRT	\$70.10

**FIELD COVERS
INCLUDE 50
SANDBAGS**



UNIVERSITY OF ARKANSAS - LAFAYETTE, ARKANSAS

STORAGE ROLLERS



Heavy-duty 28" double wall corrugated HDPE rollers for storing your full field covers. 34' & 40' rollers come in two pieces for easy assembly on the field with hardware included. **Actual shipping charges apply.**

20' Long (90'x120' covers, 240lbs)	BRLR20	\$1,194.05
34' Long (160' covers, 400lbs)	BRLR34	\$1,920.49
40' Long (170' covers, 500lbs)	BRLR40	\$2,143.57

ECONOMY STORAGE ROLLER COVERS

Economy covers are constructed of heavy field tarp material. Silver/white color only!

20' Economy Roller Cover	BESRCV20	\$203.06
34' Economy Roller Cover	BESRCV34	\$429.00
40' Economy Roller Cover	BESRCV40	\$400.40

HEAVY-DUTY STORAGE ROLLER COVERS



Heavy-duty 18 oz. vinyl cover comes in royal, navy, dark green, black, white, gray, burgundy, brown, yellow, red, or tan. Lettering optional. Custom designs available. Please specify color.



20' Heavy-Duty Roller Cover	BSRCV20	\$471.90
34' Heavy-Duty Roller Cover	BSRCV34	\$726.44
40' Heavy-Duty Roller Cover	BSRCV40	\$822.25
Block-Style Lettering One Color, 14"	BSRCVLTR	\$45.76

FIELD PROTECTORS

PROMESH INFIELD PROTECTORS



CUSTOM LOGOS

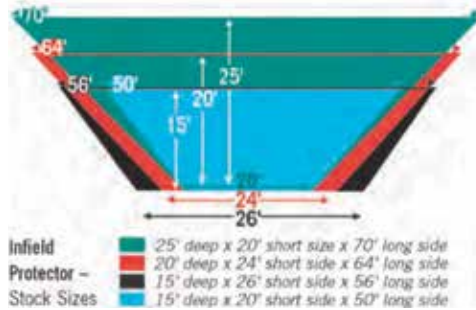

Heavy-duty mesh infield covers protect your natural turf in front of the batting cage and other high-wear areas. Premium mesh is the most durable mesh available! Strong enough to withstand spike cleats!

STANDARD 90Z MESH

3-YEAR WARRANTY

DIMENSIONS	ITEM#	MRSP
15'x20'x50'	BVCM50	\$712.14
15'x26'x56'	BVCM60	\$913.77
20'x24'x64'	BVCM64	\$1,012.44
25'x20'x70'	BVCM70	\$1,266.98

Available in: Dark Green, Black and Royal Blue.



PREMIUM 140Z MESH

5-YEAR WARRANTY

DIMENSIONS	ITEM#	MRSP
15'x20'x50'	BVCP50	\$929.50
15'x26'x56'	BVCP60	\$1,086.80
20'x24'x64'	BVCP64	\$1,195.48
25'x20'x70'	BVCP70	\$1,505.79

Available in: Dark Green, Red, Black, Royal Blue, Kelly Green, Grey, Navy Blue, Maroon, Purple, Orange, Yellow, Carolina Blue & White.



PROMESH TWO-PIECE CAGE COLLAR



Heavy-duty cage collar is made from our ProMesh 14 oz. vinyl poly making it the thickest, longest lasting, most durable material on the market! Perfect for protecting field/home plate areas during batting practice. Will stand up to steel spike traffic. Allows more air & water passage than closed fabrics. Collar will not hold water. Sewn borders with grommets on all sides. Can be customizable with letters & logos.

Size: 20' x 18' x 8' w/ 12' home plate radius.

Available in: Dark Green, Red, Black, Royal Blue, Kelly Green, Grey, Navy Blue, Maroon, Purple, Orange, Yellow & Carolina Blue.



Promesh Two-Piece Cage Collar	BIFMP	\$1,960.53
-------------------------------	-------	------------

IN-GROUND TEMPORARY FENCING



Fencing features a soft, durable mesh fabric with sewn sleeve sections easy installation of poles. Permanent reinforced vinyl pockets spaced every 10' provides ultimate stability. Slide poles into vinyl pockets and drive directly into ground or slide into optional ground sleeves. Poles feature a locking top cap that securely attaches to the top of fencing. Fence poles are black, high gloss PVC, 5' tall. Poles can be rolled up for easy storage. Fence packages include auger and tape measure. All fencing ships truck freight.

STANDARD FENCING



WOVEN
LOOPS

COLOR OPTIONS
GREEN RED BLUE

FENCING ONLY	HGT	LGTH	POLES	MRSP
BMESH50	48"	50'	0	\$396.11
BMESH100	48"	100'	0	\$288.86
BMESH150	48"	150'	0	\$396.11
ENCE PACKAGE				
BDTEMP50	48"	50'	6	\$338.91
BDTEMP100	48"	100'	11	\$564.85
BDTEMP150	48"	150'	16	\$699.27
HOME RUN FENCE PACKAGE				
BDTEMP200	48"	314'	33	\$699.27
BDTEMP300	48"	471'	49	\$2,145.00

PREMIUM FENCING



★ BEST SELLER!

COLOR OPTIONS
GREEN RED BLUE

VINYL SLEEVE
POCKETS FOR
EASY INSTALL

FENCING ONLY	HGT	POLES	MRSP
BPMESH50	48"	50'	\$354.64
BPMESH100	48"	100'	\$612.00
BPMESH150	48"	150'	\$909.48
PRO FENCE PACKAGE			
BPOF50	48"	50'	\$480.48
BPOF100	48"	100'	\$913.77
BPOF150	48"	150'	\$1,141.00
HOME RUN FENCE PACK			
BPOF200	48"	314'	\$2,435.00
BPOF300	48"	471'	\$3,895.32

GROUND SLEEVES

Optional ground sleeves are 12" black, high gloss PVC with pointed tips for easy installation. Ground sleeve caps are included when poles are removed.

GROUND SLEEVES ARE NOT INCLUDED IN FENCE PACKAGES!

OPTIONAL GROUND SLEEVES		
1	BTFGS	\$15.37
6	BTFGS6	\$82.94
11	BTFGS11	\$140.14
16	BTFGS16	\$190.19
33	BTFGS33	\$384.67
49	BTFGS49	\$490.49

INDIVIDUAL COMPONENTS

TempFence Pole	BTPOLE	\$22.52
Reinforced End Pole	BRPOLE	\$79.72
TempFence Ground Sleeve	BTFGS	\$15.37
PVC Driving Tool	BPVCT	\$26.60
12" Auger Bit	BAUG12	\$57.20
Heavy-Duty Rubber Mallet	BMALLET	\$40.76

EASY SET UP & TAKE DOWN!

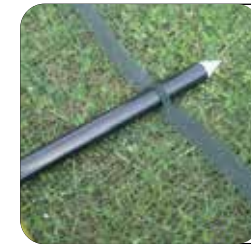

1
Insert poles into fencing.



2
Attach fence to top cap.



3
Mark & drill holes



4
Place poles & sockets in holes.



5
Roll up fencing with poles in place.

ABOVE GROUND TEMPORARY FENCING

WHICH FENCE KIT DO YOU NEED?



Use your portable fencing on synthetic turf, asphalt, concrete, or natural turf. No holes required! Durable, yet soft and easy-to-handle. Quick and easy to set-up and take down. Weighted for each pole to stand up to wind.

STANDARD ABOVE GROUND FENCING

WOVEN LOOPS

ITEM#	HGT	LGTH	POLES	MRSP
BDTEMP50AG	48"	50'	6	\$1,158.30
BDTEM-P100AG	48"	100'	11	\$1,960.53
BDTEM-P150AG	48"	150'	16	\$2,591.16
BDTEM-P200AG	48"	314'	33	\$4,937.79
BDTEM-P300AG	48"	471'	49	\$7,275.84

PREMIUM ABOVE GROUND FENCING

VINYL SLEEVE POCKETS

ITEM#	HGT	LGTH	POLES	MRSP
BPOF50AG	48"	50'	6	\$1,747.46
BPOF100AG	48"	100'	11	\$2,957.00
BPOF150AG	48"	150'	16	\$3,915.34
BPOF200AG	48"	314'	33	\$7,527.52
BPOF300AG	48"	471'	49	\$10,986.69

INDIVIDUAL COMPONENTS

2' Long Weighted Base Pipe	BTFWP2	\$37.18
4' Long Weighted Base Pipe with 4-way Fitting	BTFWP4	\$68.64
Hitch Pin	BTFHP	\$6.44
C-Clamp	BTFCL	\$8.18

DISTANCE FROM HOME TO CENTER	APPROXIMATE FENCE LENGTH
50'	79'
100'	157'
150'	236'
200'	314'
300'	471'

SOFTBALL & LITTLE LEAGUE

KIT INCLUDES:

- 314' of fencing in one piece in blue, green or red.
- 33 fence poles
- 12" auger
- Tape measure

Standard In-Ground	BDTEMP200	\$1,421.42
Premium In-Ground	BPOF200	\$2,435.00
Standard Above Ground	BDTEMP200AG	\$4,937.79
Premium Above Ground	BPOF200AG	\$7,527.52

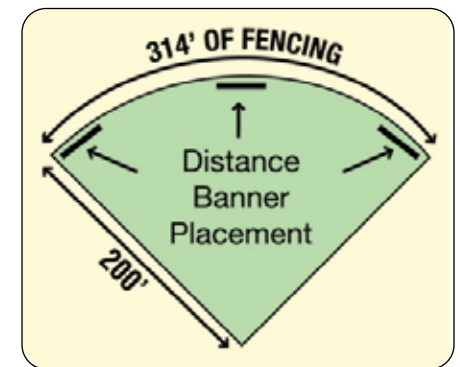
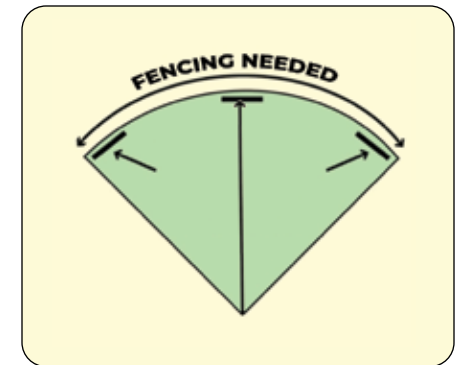

BASEBALL & MEN'S SOFTBALL

KIT INCLUDES:

- 471' of fencing in one piece in blue, green or red.
- 49 fence poles
- 12" auger
- Tape measure

Standard In-Ground	BDTEMP300	\$2,145.00
Premium In-Ground	BPOF300	\$3,895.32
Standard Above Ground	BDTEMP300AG	\$7,275.84
Premium Above Ground	BPOF300AG	\$10,986.69

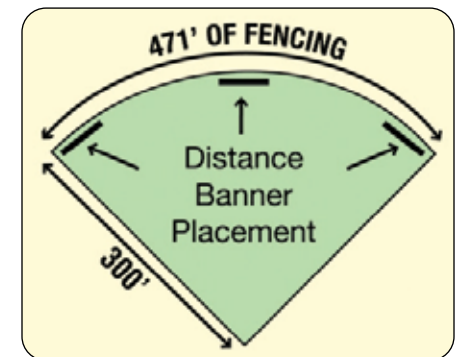

SAFETY FENCE CAP

FENCE CROWN/POLY CAP



Protect your players against injury from the top of any chain link fence while you make your ballpark look good. 4 1/2" diameter corrugated plastic tubing outlines your ballpark and with our polyester windscreen, gives you that "big league" look. Rolls are pre-slit for easy installation. Ships truck freight. Actual freight charges apply.

Available in: Yellow, Black & Yellow Gold.

Yellow 250' Roll	BFC250Y	\$350.35
Yellow 100' Roll	BFC100Y	\$202.35
Gold Yellow 250' Roll	BFC250GY	\$350.35
Gold Yellow 100' Roll	BFC100GY	\$202.35
Black 250' Roll	BFC250B	\$350.35
Black 100' Roll	BFC100B	\$202.35

SAFETY TOP CAP



Protects against chain link injuries, increases visibility and adds beauty to any field. Please specify color when ordering. Comes 80 linear feet per box. 10 pieces, 8 feet long with tie wraps included.

15-YEAR WARRANTY

Green Safety Top Cap	BSTCGR	\$192.00
Blue Safety Top Cap	BSTCBL	\$192.00
Red Safety Top Cap	BSTCRD	\$192.00
Yellow Safety Top Cap	BSTCYL	\$192.00
White Safety Top Cap	BSTCWH	\$192.00
Black Safety Top Cap	BSTCBK	\$192.00

ATTACHING TOOL



Our Fence Crown Attaching Tool makes installation easy! The installer spreads the fence crown over the fence as you pull.

Attaching Tool	BFCAT	\$92.24
----------------	-------	---------

TIE WRAPS



19" Tie Wraps, 100 per pack.

Yellow Tie Wraps	BFCTWRPY	\$45.05
Green Tie Wraps	BFCTWRPG	\$48.48
Black Tie Wraps	BFCTWRPB	\$45.05

FIELD SCREEN

STANDARD MESH FIELD SCREEN



Windscreen attaches to any fence to give you an easy and economical solution to just about any outdoor court or field enclosure need. Used to block wind disturbances, unwanted onlookers or other distractions. It provides an excellent visual background for players, and can also be used to wall off special field sections or unsightly areas.

FEATURES:

- Maximum UV sunlight protection
- Black grommets for a more modern look
- Center lacing lip & wind flaps standard for 9' and taller screens

Available in: Dark Green, Red, Black, Royal Blue, Kelly Green, Grey, Navy Blue, Burgundy, Purple, Orange, Yellow, Carolina Blue, Tan, Brown & White.



5' Standard Mesh Screen	BVCM5	\$1.07
6' Standard Mesh Screen	BVCM6	\$1.07
9' Standard Mesh Screen	BVCM9	\$1.17

FIELD SCREEN LETTERING

Give your fences some style and team spirit with a customized field screen. Even some simple lettering can improve the look of your team's field or stadium.

Available in: White, Black, Yellow, Athletic Gold, Royal Blue or Red letters and/or numbers

CALL FOR PRICING ON CUSTOM PRINTED LOGOS!

14" Block Style	BVCML14	\$40.04
24" Block Style	BVCML24	\$54.34
30" Block Style	BVCML30	\$62.92

36" Block Style	BVCML36	\$78.65
42" Block Style	BVCML42	\$94.38

No returns accepted on custom field screen

WARRANTY:

All field screens and windscreens are fully warranted against fabric & manufacturing defects. 3-year pro-rated warranty against breakdown from UV sunlight.

PROMESH FIELD SCREEN



Made from 16 oz. vinyl coated polyester making it the thickest, longest lasting, most durable windscreen available! Pro Mesh windscreen is so durable we are offering a 5-Year limited warranty! All pieces are custom cut to your specific dimensions and come standard with grommets spaced every 18". All borders are now Heat-Sealed with 21st century heat sealing technology.

ADVANTAGES OF HEAT-SEALING:

- No possibility of thread breaks
- More professional look

Standard heights are 6' and 9'. Please call for pricing on pieces larger than 9' high.

Available in: Dark Green, Red, Black, Royal Blue, Kelly Green, Grey, Navy Blue, Maroon, Purple, Orange, Yellow, Carolina Blue & White.

5' ProMesh Screen	BPMESH5	\$1.27
6' ProMesh Screen	BPMESH6	\$1.29
9' ProMesh Screen	BPMESH9	\$1.37



EXTREME SCREEN



ExtremeScreen®80 has been proven to drastically reduce wind maintenance while staying securely attached to your fence. The first ever patented windscreens design is ideal for baseball fields, athletic facilities, and other applications that experience high winds and the damage they can cause. This premium wind-resistant privacy screen consistently delivers unmatched durability and performance.

The First Ever Patented Windscreens

Our customizable wind-resistant privacy screen is also fade-resistant, tough, and visually appealing. At the core of the ExtremeScreen®80 revolutionary patented design is a knitted hexagonal pattern. This unique structure forms a honeycomb lattice that diffuses airflow without creating drag on the fence, the fabric, or the attachment points.

- **Material** – High-density knitted polyethylene
- **Standard heights** – 6' and 9', with custom heights available in all colors
- **Density/opacity** – 80%
- **Material/weight** – 5 oz/square yard
- **Hems** – 1.75" wide, 3-ply reinforced with 18 oz vinyl
- **Grommets** – #2 brass grommets every 12" triple-grommets corners
- **Warranty** – 7 years

Available in: Royal Blue, Green, Black, Navy Blue.



6" Extreme Screen	EXTREME6	\$7.04 LINEAR FOOT
9" Extreme Screen	EXTREME9	\$10.81 LINEAR FOOT

RAIL PADDING

SAFEFOAM PADDING



Add padding onto any pole or rail 2" or less in diameter, as well as across your chain link fence tops. Padding is 3/4" with an extra-durable toughskin coating. Sold in 8' lengths, pre-split for easy installation. Ships truck freight.

Specify Color when ordering: (YE) Yellow, (GR) Green, (RB) Royal Blue, (NB) Navy Blue, (RD) Red, (BL) Black, (PU) Purple, (GY) Grey or (SB) Sky Blue.



SafeFoam Padding	BSFPAD	\$62.56
19" Tie Wraps (100 pack)	BFC100	\$219.56

PREMIUM ROUND RAIL PADDING



- Fits up to 2 1/2" diameter pipe
- Rail & Pole Pads can be customized for any diameter pole
- Priced per liner foot for all.

Available in: Forest Green, Red, Black, Royal Blue, Kelly Green, Grey, Navy Blue, Burgundy, Purple, Orange, Yellow, Carolina Blue, Tan & White.



1" Thick Premium Round Rail Padding	BRLPAD1	\$194.12
2" Thick Premium Round Rail Padding	BRLPAD2	\$211.64

2-SIDED PREMIUM SQUARE RAIL PADDING



- 2 sided pad protects top rail & front side of dugout
- 2" foam, 18oz vinyl, backed with 3/4" wood backed board
- 6 3/4" top pad depth, 8 3/4" front height
- Can be printed with full color lettering & logos
- Hardware not included.
- Priced per linear foot.

Available in: Forest Green, Red, Black, Royal Blue, Kelly Green, Grey, Navy Blue, Burgundy, Purple, Orange, Yellow, Carolina Blue, Tan, & White.



1" Thick Premium Square Rail Padding	BSQRLPAD1
2" Thick Premium Square Rail Padding	BSQRLPAD2

CALL FOR QUOTE

PREMIUM SQUARE 3 SIDED RAIL PADDING



- 3 sided pad protects top rail and both sides of dugout
- 2" foam, 18oz vinyl, backed with 3/4" wood backed.
- 5 1/2" top pad depth, 6 3/4" front height
- Can be printed with full color lettering & logos
- Hardware not included
- Priced per linear foot for all.

Available in: Forest Green, Red, Black, Royal Blue, Kelly Green, Grey, Navy Blue, Burgundy, Purple, Orange, Yellow, Carolina Blue, Tan, & White.



Premium Square 3-Sided Rail Padding	BRLPADSQ3
-------------------------------------	------------------

CALL FOR QUOTE

BACKSTOP/WALL PADDING

PREMIUM FOLDING BACKSTOP PADDING



LAUSANNE COLLEGIATE SCHOOL - MEMPHIS, TENNESSEE

Made of 18oz. vinyl covers with 2" polyfoam filling. Pads are made to fold in 2' wide panels for easy storage and shipping. Grommets are placed along the top, bottom, and sides for anchoring. Please allow 3-4 weeks for delivery. Please specify color when ordering! Ships truck freight.

Available in: Forest Green, Red, Black, Royal Blue, Kelly Green, Grey, Navy Blue, Burgundy, Purple, Orange, Yellow, Carolina Blue, Tan, Brown & White.



SIZE	ITEM #	MRSP	PAD W/ GRAPHICS	MRSP
2'H X 6'L	BSPAD26	\$268.84	BSPAD26L	\$547.69
2'H X 8'L	BSPAD28	\$313.17	BSPAD28L	\$586.30
2'H X 10'L	BSPAD210	\$376.09	BSPAD210L	\$643.50
2'H X 12'L	BSPAD212	\$446.16	BSPAD212L	\$703.56
3'H X 6'L	BSPAD36	\$393.25	BSPAD36L	\$629.20
3'H X 8'L	BSPAD38	\$490.49	BSPAD38L	\$779.35
3'H X 10'L	BSPAD310	\$561.99	BSPAD310L	\$561.99
3'H X 12'L	BSPAD312	\$647.79	BSPAD312L	\$1071.07
4'H X 6'L	BSPAD46	\$480.48	BSPAD46L	\$779.35
4'H X 8'L	BSPAD48	\$597.74	BSPAD48L	\$966.68
4'H X 10'L	BSPAD410	\$719.29	BSPAD410L	\$1,208.35
4'H X 12'L	BSPAD412	\$832.26	BSPAD412L	\$1,430.00

CUSTOM STADIUM PADDING



Our custom wood backed stadium padding features 18oz coated vinyl with high UV rating. All pads manufactured with 3/4" exterior grade water sealed plywood backing and bottom grommet weep holes to allow moisture to drain. Options include 2", 3", or 4" Soft IFD 100 foam. Priced per linear foot.

Available in: Forest Green, Red, Black, Royal Blue, Kelly Green, Grey, Navy Blue, Burgundy, Purple, Orange, Yellow, Carolina Blue, Tan, Brown & White.



FOAM	ITEM #	PAD W/ GRAPHICS	MRSP
2" Soft IFD 100	BWPAD2	BWPAD2L	\$24.91
3" Soft IFD 100	BWPAD3	BWPAD3L	\$27.58
4" Soft IFD 100	BWPAD4	BWPAD4L	\$33.10

ALUMINUM "Z" MOUNTING CHANNELS

Aluminum Mounting channels with 'Z' clips for easy installation. Priced per linear foot.

Aluminum "Z" Mounting Channels	BWPADZC	\$5.15
--------------------------------	---------	--------



FACILITY SOLUTIONS

GYM WALL PADDING



Our indoor wall padding features 18 oz. tough PVC vinyl cover, 2-inch foam cushioning and a 7/16" wood backer board. Call for pricing on custom sizes.

Available in: Forest Green, Royal Blue, Red, Navy Blue, Gray, Burgundy, Light Blue, Purple, Yellow, White, Tan, Black, Orange & Kelly Green.



SIZE	2" MEDIUM FIRM FOAM	MRSP	2" MEDIUM FIRM FOAM W/ GRAPHICS	MRSP
2'W x 5'H	IWP25F	\$157.30	IWP25FG	\$350.35
2'W x 6'H	IWP26F	\$171.60	IWP26FG	\$364.65
2'W x 7'H	IWP27F	\$198.77	IWP27FG	\$370.37

INDOOR WALL PADDING

PREMIUM FOLDING BACKSTOP PADDING



Made of 18oz. vinyl covers with 2" polyfoam filling. Pads are made to fold in 2' wide panels for easy storage and shipping. Grommets are placed along the top, bottom, and sides for anchoring. Please allow 3-4 weeks for delivery. Please specify color when ordering! Ships truck freight.

Available in: Forest Green, Red, Black, Royal Blue, Kelly Green, Grey, Navy Blue, Burgundy, Purple, Orange, Yellow, Carolina Blue, Tan, Brown & White.



SIZE	ITEM #	MRSP	PAD W/ GRAPHICS	MRSP
2'H X 6'L	BSPAD26	\$268.84	BSPAD26L	\$547.69
2'H X 8'L	BSPAD28	\$313.17	BSPAD28L	\$586.30
2'H X 10'L	BSPAD210	\$376.09	BSPAD210L	\$643.50
2'H X 12'L	BSPAD212	\$446.16	BSPAD212L	\$703.56
3'H X 6'L	BSPAD36	\$393.25	BSPAD36L	\$629.20
3'H X 8'L	BSPAD38	\$490.49	BSPAD38L	\$779.35
3'H X 10'L	BSPAD310	\$561.99	BSPAD310L	\$933.79
3'H X 12'L	BSPAD312	\$647.79	BSPAD312L	\$1,071.07
4'H X 6'L	BSPAD46	\$480.48	BSPAD46L	\$779.35
4'H X 8'L	BSPAD48	\$597.74	BSPAD48L	\$966.68
4'H X 10'L	BSPAD410	\$719.29	BSPAD410L	\$1,208.35
4'H X 12'L	BSPAD412	\$832.26	BSPAD412L	\$1,430.00

GYM FLOOR COVERS

GYM FLOOR COVERS



Ultra protection for your gym floor! Covers are constructed in 10' wide sections for easy handling.

STANDARD FEATURES:

- Ultra-durable, flame-retardant, 3-ply fabrics with PVC on both sides, so you can use either side.
- Extra-strength seams made to lay smooth & flat.
- Exceeds ADA & OSHA specs for slip-resistant surfaces.
- 15 different colors options in 18, 22, or 27 oz material!
- 8-15 year limited warranty!
- CUSTOMIZABLE WITH SCHOOL NAME, LOGO, SPONSOR & MORE!
- Rack sold seperately.

*We suggest adding 6"-12" when figuring your size to allow for overlapping of each section. (Example: For a 75' x 110' floor, order 8 sections measuring 10' x 110' each.)

18 oz. Gym Floor Cover	FLRCV18	\$1.42
22 oz. Gym Floor Cover	FLRCV22	\$1.63
27 oz. Gym Floor Cover	FLRCV27	\$1.94

SAFETY STORAGE RACKS

SAFETY MOBILE STORAGE RACK



Our Safety Mobile Rack is a great time & back saver.

FEATURES:

- 8" diameter non-marking urethane swivel-type wheels for easy mobility
- Can support up to 2,800 lbs. of fabric
- Can holds 10'-wide sections of almost any length
- Available in 6', 8' & 10' roller models
- 2 hand cranks (easy winding)
- 3 fabric clips (secure winding) per roller
- Safety Collars
- Safety Brakes



6-Roller Storage Rack	CVRACK6	\$4,018.30
8-Roller Storage Rack	CVRACK8	\$4,402.97
10-Roller Storage Rack	CVRACK10	\$4,866.29
Power Winder	CVRACKW	\$1,561.56



BASKETBALL



SCOREBOARDS

BATTERY-POWERED SCOREBOARD WITH BLUETOOTH



Battery-operated scoreboard with rechargeable battery all the functionalities of the #SCORE2. Features an exterior shot clock with Bluetooth connectivity for remote operation through its own app.

SHOT CLOCK SOLD SEPARATELY!

- User-Friendly Operation - Plug & Play, easy to use.
- Clock & Alarm - Can be used as a digital clock with alarm functionality.
- Rugged construction, built-in handle, Optional stand available.
- Multi-Sport Functionality

Shot Clock (Set of 2)	SHCLK3	\$507.49
Shot Clock Stand	SBSTND3	\$179.45
Battery-Powered Scoreboard with Bluetooth	SCORE3	\$740.01

MULTI-SPORT INDOOR/OUTDOOR SCORER & TIMER WITH BLUETOOTH



Battery-operated scoreboard with rechargeable battery. Up to 6 hours of battery life when fully charged. Can also be plugged in with included cord. Features all the same timer and game functions as our item #SCORE.

Battery-Powered Portable Scoreboard	SCORE2	\$696.40
Replacement Remote	SBRMT	\$75.78

SCOREBOARD STAND



Powder-coated frame with heavy-duty casters for easy mobility. Stand raises timer to 4' high.

SCORE2 & 3 Scoreboard Stand	SBSTND3	\$179.45
Standard Scoreboard Stand	SBSTAND	\$206.62

POSSESSION ARROW



Bright LED display features indicator lights on the top for fans, coaches and scorekeepers to easily view. Power cord included. Size: 21" x 6" x 3".

Possession Arrow	SBPARR	\$145.85
------------------	--------	----------

SCOREBOARD CARRYING CASE



Nylon bag with adjustable carrying straps. Rear pocket for power cord and owner's manual. Size: 24"L x 10"D x 16"H.

Scoreboard Carrying Case	SBTBAG	\$65.05
--------------------------	--------	---------

BALL CARTS

HEAVY-DUTY SECURE BALL LOCKER

PRO'S CHOICE

★ BEST SELLER!



Full-size HD secure locker holds 28-30 balls. Constructed of heavy duty 1" Powder-coated square steel tubing. Lockable hinged lid for security. 4 HD swivel caster wheels for easy mobility.

Size: 47"L x 24"W x 38"H.

HD Secure Ball Locker	BLOCKS	\$304.58
-----------------------	--------	----------

DELUXE BALL LOCKER



Full size locker holds 28-30 balls. Heavy steel wire mesh. Powder-coated for durability. Hinged lid can be locked. 4 HD swivel caster wheels.

Size: 42"L x 24"W x 38.5"H

HD Secure Ball Locker	BLOCK	\$260.96
-----------------------	-------	----------

3-TIER HEAVY-DUTY BALL CART

PRO'S CHOICE



Holds 15 basketballs. Strong 1" square steel tubing powder coated black for maximum protection. Includes 4 HD swivel, locking caster wheels.

Size: 49"L x 16"W x 35"H.

3-Tier HD Ball Cart	CART315	\$268.11
---------------------	---------	----------

2-TIER HEAVY-DUTY BALL CART



Holds 15 basketballs. 2-tier system for better strength and stability. Powder-coated black with 4 HD swivel caster wheels.

Size: 51"L x 19"W x 38"H

2-Tier HD Ball Cart	CART215	\$108.67
---------------------	---------	----------

DOUBLE-WIDE BALL CART



Holds 30 basketballs. Strong 1" square steel tubing powder coated black for maximum protection. Includes 4 HD swivel, locking caster wheels.

Size: 52"L x 25"W x 35" H.

3-Tier Double-Wide Ball Cart	CART330	\$413.26
------------------------------	---------	----------

BIG BALLER PRO BALL CART



NEW!

Angled design to allow for balls to roll to ends of cart. HD round tubing powder coated black for maximum protection. Holds 15 balls.

Size: 49"L x 16"W x 35"H.

Big Baller Pro Ball Cart	BIGBALLER15	\$240.96
--------------------------	-------------	----------

INDOOR RIMS

BREAKAWAY SINGLE RIM



Front mount 5/8" x 18" single rim with powder coated heavy steel construction. Universal back plate accommodates most fan-shaped and rectangular backboards. For indoor use. Includes net and mounting hardware. 4" x 5" Mounting Pattern.

Breakaway Single Rim	BBRIMBRS	\$205.41
----------------------	----------	----------

BREAKAWAY REAR MOUNT RIM



Rear mount 5/8" x 18" single rim with powder coated heavy steel construction. Compatible with rear mount backboards. Includes net and mounting hardware. 4" x 3 7/8" Mounting Pattern.

Breakaway Rear Mount Rim	BBRIMBR	\$379.98
--------------------------	---------	----------

BREAKAWAY DOUBLE RIM

Front mount 5/8" x 18" double rim. Full steel wing brace design powder coated for protection. Back plate accommodates 42" or 48" rectangular & fan-shaped backboards. Includes anti-whip net & mounting hardware. For indoor or outdoor use.

Breakaway Double Rim	BBRIMBR	\$196.27
----------------------	---------	----------



OUTDOOR RIMS

REAR MOUNT RIM



Rear mount 5/8" x 18" single rim with powder coated heavy steel construction. Includes net and mounting hardware. 4" x 3 7/8" Mounting Pattern.

Rear Mount Rim	BBRMS	\$140.96
----------------	-------	----------

HEAVY-DUTY SINGLE RIM

Regulation rim has powder-coated finish & heavy steel bracing for outdoor use. Universal back plate accommodates 42" or 48" rectangular & fan-shaped backboards. Front mount 5/8" x 18" single rim Includes nylon net & mounting hardware.

HEAVY-DUTY SINGLE RIM	BBRIMS	\$96.17
-----------------------	--------	---------

HEAVY-DUTY DOUBLE RIM



Heavy-duty playground rim with welded wing plates & 5/8 x 15 braces. Front mount 18" double rings are 3/4" and 1/2". Back plate accommodates 42" or 48" rectangular & fan-shaped backboards. Includes nylon net & mounting hardware. For outdoor use.

Heavy-Duty Double Rim	BBRIMD	\$114.40
-----------------------	--------	----------



BACKBOARDS

ACRYLIC RECTANGULAR BACKBOARD



42" x 60" backboard made of 3/8" UV-resistant acrylic permanently attached to a 3/4" x 1 1/2" welded steel tubular support frame. Direct mount design allows for permanent attachment of board to post & easy rim replacement. For indoor or outdoor use.

BACKBOARD, PADDING, RIM & NET SOLD SEPARATELY.

Acrylic Rectangular Backboard	BBABB	\$831.55
-------------------------------	-------	----------

PREMIUM BACKBOARD PADDING



High-density urethane foam with a tough exterior skin. Easy bolt-on design fits all 72" wide glass backboards. Kit includes 2 pieces of padding for one backboard and mounting hardware. For indoor use only.

Available in: Forest Green, Royal, Red, Navy, Gray, Maroon, Purple, Gold, Black, Orange, Kelly Green, Pink, Columbia Blue, Burgundy, and Brown.



Premium Backboard Padding	BBPAD	\$210.57
---------------------------	-------	----------

STEEL RECTANGULAR BACKBOARD

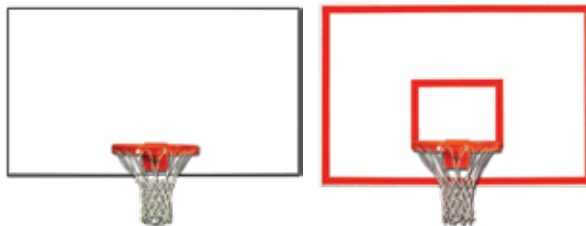

42" x 60" steel backboard with white powder coated finish. Choose from screened target and border or solid white. For indoor or outdoor use. 5" x 5" Mounting Pattern. **RIM & NET SOLD SEPARATELY.**

Steel Backboard with Target & Border	BBSRTB	\$774.27
Steel Backboard Solid White	BBSRW	\$704.78

OUTDOOR BASKETBALL PLAYGROUND SYSTEM



Systems feature an industry standard 4 1/2" O.D. post. Goose-neck packages include post, 4' extension, Aluminum fan-shape backboard with target & border, & a super double ringed rim.

Complete Playground System (includes BBNECK4 Goose-neck)	BBAL454	\$1,649.26
4 1/2" O.D. Goose-neck	BBNECK4	\$829.40
Front Mount with Target & Border	BBFTB	\$817.13
Heavy-Duty Double-Rim	BBRIMD	\$114.40

FAN SHAPED STEEL BACKBOARD



35" x 54" HD 12-gauge steel backboard with white powder-coat finish. Reinforced mounting points for reduced vibration. Choose from screened target only or screened target & border. For indoor or outdoor use.

RIM & NET SOLD SEPARATELY.

Front Mount Backboard	BBFT	\$536.25
Front Mount Backboard with Target & Border	BBFTB	\$817.13
Rear Mount Backboard	BBRMW	\$563.85
Rear Mount Backboard with Target	BBRIMD	\$114.40

MAKE

WINNING

POSSIBLE™



TRAINING



SPORTS SPEED & AGILITY

SPEED CHUTE



This is the ultimate resistance tool for improving speed, stamina, strength & acceleration. Chute opens while running to provide resistance. Comes with carry bag.

40" Speed Chute	ASC40	\$67.91
48" Speed Chute	ASC48	79.35
54" Speed Chute	ASC54	\$90.79

PRO AGILITY LADDER



The ultimate speed and agility training ladder. Made from 20" wide flat plastic rungs & 27' long nylon tape border. Distance between rungs is fully adjustable. Use narrow spacing on this workout ladder for short and quick steps or wider spacing for longer strides. Comes with carry bag.

Pro Agility Ladder	ALPRO	\$67.91
--------------------	-------	---------

SPEED SLED



Improves speed, acceleration & leg strength. Includes powder-coated steel sled & shoulder harness with belt attachment. Add-on weights not included.

Speed Sled	ASLED	\$158.72
------------	-------	----------

PLYOMETRIC BOXES



Features heavy-duty, powder-coated steel frame. Top surface constructed of 18" square laminated wood covered with a non-slip synthetic surface.

12" Plyometric Box	PLY012	\$108.67
18" Plyometric Box	PLY018	\$120.11
24" Plyometric Box	PLY024	\$133.69
30" Plyometric Box	PLY030	\$172.30
36" Plyometric Box	PLY036	\$204.48

AGILITY HURDLES

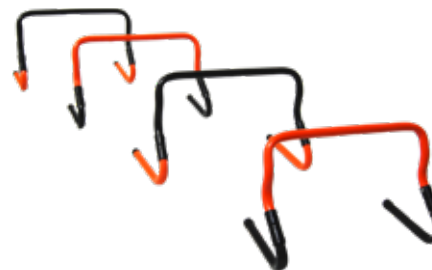

Constructed of heavy-duty PVC. Hurdle can be adjusted from 6" to 12" by twisting the legs in reverse direction. Comes in sets of 4.

Agility Hurdles	AH612	\$90.79
-----------------	-------	---------

SPORTS SPEED & AGILITY KIT



KIT INCLUDES:

- Dual Harness (Evasion belt)
- 48" Speed Chute
- Shoulder/Speed Harness
- (2) 6" Hurdles
- (2) 9" Hurdles
- (2) 12" Hurdles
- (2) 5m Speed Ladders
- (12) Saucer Cones
- Leg Toning Tube
- Reaction Ball
- Trigon Sports Carry Bag

Sports Speed & Agility Kit	AGKIT	\$120.05
----------------------------	-------	----------



FOOTBALL



FOOTBALL TRAINING AIDS

FOOTBALL PASSING NET WITH SWIVEL TOP



- Powder coated steel frame
- Catch net is adjustable to 7 different swivel positions
- All-terrain turf tires with locking wheels
- Red center target with red outline to easily identify at long distances

Size: 51"W x 8'H (At tallest setting)

Football Passing Net With Swivel Top	FBPASS	\$574.85
--------------------------------------	--------	----------

SIDELINE PRO COLLAPSIBLE KICKING CAGE



Strong yet light weight aluminum collapsible kicking cage. Quick and easy assembly in seconds. The high-grade durable net attaches easily using heavy duty Velcro sewn into the 18 oz vinyl.

Size: 87" tall x 48" wide

Sideline Pro Collapsible Kicking Cage	FBKSPC	\$367.50
---------------------------------------	--------	----------

PROFESSIONAL KICKING CAGE



Features a sturdy 2" Powder-Coated Steel Base w/ 15/8" uprights. Net made from Heavy-duty knotless netting. Designed for quick & easy set-up and take down. Comes complete with carry bag.

Size: 48" x 48" x 86" tall.

Professional Kicking Cage	FBPROK	\$363.21
Replacement Net	FBPROKN	\$113.67

RUNNING ROPES



FULLY ADJUSTABLE HEIGHT

Designed for building foot speed and agility. 1" Galvanized steel tube frame, powder-coated black with suspended rope running grid. Adjustable height. Designed for quick assembly and safety with tubing frame outside the running grid.

Size: 17' L x 5' W.

Running Ropes	FBHSTP	\$295.28
Replacement Ropes	FBROPE	\$113.67

EQUIPMENT STORAGE

DELUXE HELMET CART



HD steel rack comes with 4" HD swivel-lock wheels. Rack holds 60 football helmets. Size 59"H x 59"L x 24"D allows rack to fit through standard doorway.

Deluxe Helmet Cart	FBHCART	\$326.03
--------------------	---------	----------

PRO DELUXE SHOULDER PAD RACK



Holds 60 XXL Pads! Heavy-duty steel bottom frame with retractable pull handle and large locking wheels for easy transport. Steel uprights with bottom position bar allows for neat and orderly stacking.

Pro Deluxe Shoulder Pad Rack	FSPR60	\$304.58
------------------------------	--------	----------

SHOULDER PAD HANGERS

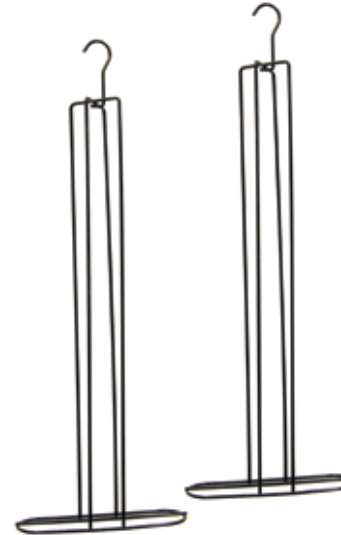

All steel, welded construction powder coated black. Each shoulder Pad hangers holds 14 shoulder pads. Sold in sets of 2.

Shoulder Pad Hangers - Set of 2	SPHGR	\$54.65
---------------------------------	-------	---------

AERIAL ATTACK FOOTBALL MACHINE



The Aerial Attack Football machine is designed for football programs on a tight budget. This unit will deliver right-footed deep spiral punts that turn over as well as end-over-end kickoffs for coverage and return practice. Plus...it throws both long and short passes for receiving and defensive drills. It will pivot in any direction to challenge the defensive coverage or to instantly throw to an exact location.

Aerial Attack Football Machine	FBAAFM	\$2,999.00
--------------------------------	--------	------------

GAMEDAY FIELD LAYOUT

Professional grade 1/16" polyethylene stencils are flexible, allowing them to conform to any smooth or rough surface that needs marking. Get the sharpest, most accurate stencil markings possible. Polyethylene stencils make cleanup quick and easy. When paint dries it simply flakes off. Stencils are backed by a lifetime warranty!

FOOTBALL FIELD STENCIL KITS



STENCIL KITS INCLUDE:

- 1 pc. Characters (# 0-5)
(PRO Kit includes 2 pc. characters)
- Directional Arrow

3' Football Marking Kit (1/16")	FMK3D	\$606.32
3' Football Marking Kit (1/8")	FMK3M	\$1,054.51
6' Football Marking Kit (1/16")	FMK6D	\$1,023.05
6' Football Marking Kit (1/8")	FMK6M	\$1,594.85
6' Pro-Style Football Stencil Kit (1/16")	FMKPRO	\$1,227.94



HASH MARKS STENCIL KITS



STENCIL KITS INCLUDE:

- 4 Hash Marks on One Panel

4"x18" Hash Stencil Kit	FBHASH	\$437.98
-------------------------	--------	----------

PROLINE FOOTBALL FIELD LAYOUT SYSTEM

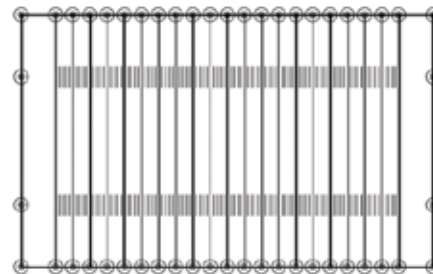

Locate measurements and quickly mark any size football field. If marked lines become too faded to follow for restriping, locators remain in place. Restrriping the faded area, and your marked lines are relocated exactly. Additional markers available in 6 and 10-piece sets can be used to locate inbound lines, coaches' boxes and more. All sets include 50 locators, starting tool and 600' roll of cord.

Football Field Layout System	FLS50	\$580.58
------------------------------	-------	----------

GAMEDAY FIELD EQUIPMENT

SOLID FOAM WEIGHTED SIDELINE MARKERS



Triangle weighted sideline markers are a 1 piece foldable design. Each set includes 2 pieces each: "G" (Goal) through "40" and one "50" marker.

Available in: Orange/black

Solid Foam Weighted Sideline Markers (Set of 11)	FBST11	\$321.49
--	--------	----------

WEIGHTED ANCHORLESS PYLONS

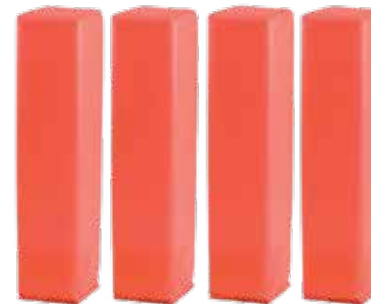

Pylons are one-piece solid foam with weighted bottoms. Sold in sets of 4. Available in Orange.

Football Field Layout System	FBPYLS	\$66.24
------------------------------	--------	---------

DELUXE DOWN BOX & CHAIN SET

Unbreakable padded down box with Black foam padding. Chain set is 6'10" with orange foam padding and 12" flip-over numbers. Chain set is 7'6" with 15" padded bull's eye with Orange padded banners and poles. Available in Orange/black.



Deluxe Down Box & Chain Set	FBDLS3	\$561.19
Down Box Only	FBDB03	\$234.00
Chain Set Only	FBCS03	\$384.42

AEROSOL FIELD PAINT



Fast-drying, water resistant. Universal tip fits most machines. 12 (20oz.) cans per case. Available in white, red, yellow, purple, royal, navy, black, orange, maroon, turf green, brown, silver, pink & gold.

White Aerosol Field Paint	LINEW	\$91.83
Color Aerosol Field Paint	LINEC	\$94.00

SIDELINE & TRACK PROTECTORS



PROMESH SIDELINE PROTECTOR

Our ProMesh material features heavy-duty 14 oz. mesh that has extreme tear resistance. Tarps are heat-fused for abrasion resistance to spikes and breathable to allow air and water passage. Grommets are spaced at 3' intervals around perimeter. 12 stock colors available. Optional lettering & logo printing available. Ships truck freight.

AVAILABLE COLOR OPTIONS:



STOCK SIZE	ITEM#	
12' x 50'	FPM1250	\$676.39
12' x 75'	FPM1275	\$999.57
12' x 100'	FPM12100	\$1,546.60
12' x 125'	FPM12125	\$1,653.08
12' x 150'	FPM12150	\$1,990.56
15' x 50'	FPM1550	\$833.69
15' x 75'	FPM1575	\$1,241.24
15' x 100'	FPM15100	\$1,661.66
15' x 125'	FPM15125	\$2,080.65
15' x 150'	FPM15150	\$2,486.77

BLANKET-STYLE SIDELINE PROTECTOR



Blanket material features non-woven poly fabric that is heather gray in color to deflect heat. Blanket material is breathable to allow air and water passage. Grommets are spaced at 3' intervals around perimeter.



SIZE	ITEM#	
14' x 50'	FST1450	\$990.99
14' x 75'	FST1475	\$1,484.34
14' x 100'	FST14100	\$1,976.26
14' x 125'	FST14125	\$2,429.57
14' x 150'	FST14150	\$2,900.04

WEIGHTED TRACK PROTECTOR

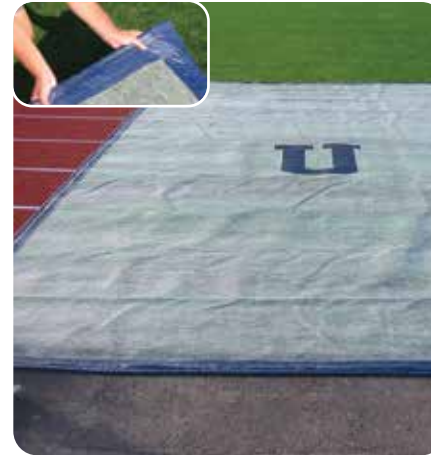

Premium heavyweight 16 oz. non-woven polypropylene fabric. Heat tempered on both sides for excellent durability to cleat traffic. Light gray color will not absorb heat like dark colors. Features a weighted perimeter with vinyl border that stays in place without the need for stakes or sand bags that could damage track surface. Choose from 14 different border colors!

BORDER COLOR OPTIONS:



SIZE	ITEM#	
7' x 30'	WTP730	\$846.56
7' x 40'	WTP740	\$995.28
7' x 50'	WTP750	\$1,249.82
14' x 30'	WTP1430	\$1,119.69
14' x 40'	WTP1440	\$1,327.04
14' x 50'	WTP1450	\$1,614.47

PROMESH WEIGHTED TRACK PROTECTOR



Our ProMesh material features heavy-duty 14 oz. mesh that has extreme tear resistance. Tarps are heat-fused for abrasion resistance to spikes and breathable to allow air and water passage. Features a weighted perimeter with vinyl border that stays in place without the need for stakes or sand bags that could damage track surface. Optional lettering & logo printing available. Ships truck freight.

AVAILABLE COLOR OPTIONS:



SIZE	ITEM#	
6' x 30'	PMWTP630	\$000.00
6' x 40'	PMWTP640	\$000.00
6' x 50'	PMWTP650	\$000.00
12' x 30'	PMWTP1230	\$000.00
12' x 40'	PMWTP1240	\$000.00
12' x 50'	PMWTP1250	\$000.00

GOAL POSTS

OFFICIAL FOOTBALL GOAL POSTS



Goose-neck style goalposts are manufactured of heavy Schedule 40 galvanized steel with a 4^{1/2}" OD (5' offset). Goal posts feature 3" O.D. crossbars and 2^{3/8}" O.D. x 20' H aluminum uprights. Fully adjustable in 2 directions for precise alignment. Goals can be permanently installed in concrete footings or set in optional ground sleeves. Available in powder-coated white or yellow with either 23' 4" High School or 18' 6" Collegiate crossbars. Ships truck freight.

COLOR	CROSSBAR	ITEM #	
Yellow	18' 6"	FBGP4YC	\$8,723.00
White	18' 6"	FBGP4WC	\$8,723.00
Yellow	23' 4"	FBGP4YHS	\$6,769.62
White	23' 4"	FBGP4WHS	\$7,304.44
Optional 4.5" ground sleeves		FBGP4GS	\$1,716.00

GOAL POST NETS

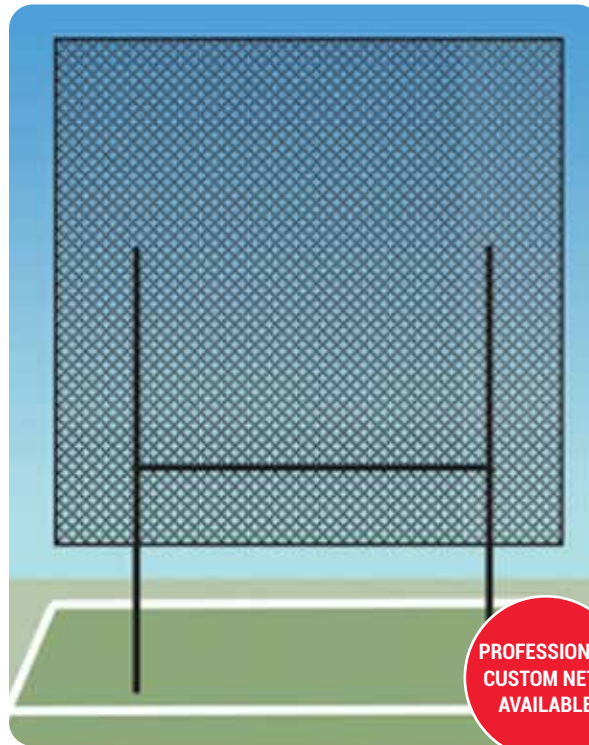

Nets are designed for use behind football goal posts to retrieve kicked balls. Netting is #18 with a 4" square mesh border on all four sides with steel rings in corners for easy hanging. All nets are weather & UV treated to guarantee years of service.

SIZE	ITEM #	
30' H x 30' W	FGN3030	\$378.29
30' H x 35' W	FGN3035	\$433.20
35' H x 45' W	FGN3545	\$501.33
40' H x 40' W	FGN4040	\$660.23
40' H x 45' W	FGN4045	\$747.32

GOAL POST PADS

Made from 18 oz. vinyl with 4" urethane foam. Standard height is 6' with hook & loop Velcro or laced-grommet closures. Custom heights & thicknesses available! Ships truck freight. Shown with optional custom print. Call for custom pricing.

Available in: Forest Green, Royal, Red, Navy, Gray, Maroon, Sky Blue, Purple, Yellow, White, Tan, Black, Kelly Green and Orange!

4" Velcro Closure	PPAD4V	\$421.85
4" Laced Closure	PPAD4L	\$690.69
6" Velcro Closure	PPAD6V	\$493.35
6" Laced Closure	PPAD6L	\$762.19



DUMMIES & PADS

STAND-UP DUMMIES



Heavyweight durable vinyl design makes the Stand-Up dummy strong, firm and durable. Available with replaceable bottoms. Great for use of all levels of players.

Color options:



42" x 14" Stand Up Dummy	FPSU42	\$190.30
48" x 14" Stand Up Dummy	FPSU48	\$209.70

HALF-ROUND DUMMIES

Dual-purpose for step-over and blocking drills. Handles allow for use as a blocking dummy, while the half-round design gives it versatility for speed & agility drills.

Color options:



42" x 14" x 7" Half Round Dummy	FPHR147	\$140.54
42" x 16" x 6" Half Round Dummy	FPHR166	\$168.17



STEP-OVER DUMMIES

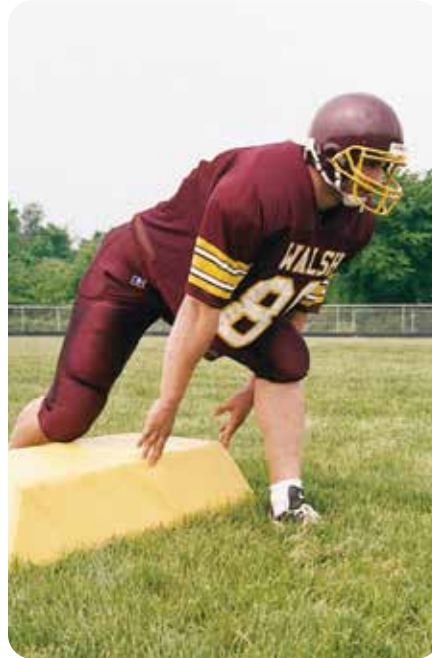

Trapezoidal design keeps dummy in place. 18 oz. vinyl coated nylon, double stitched seams and reinforced handle.

Color options:



8" x 18" x 48" x 8" Step-Over Dummy	FPSO8	\$198.88
12" x 18" x 48" x 8" Step-Over Dummy (Black not available in 12")	FPSO12	\$254.05

FOREARM PADS



Reinforced vinyl cover with 4" thick Poly-Foam filling, contoured forearm design and elbow protectors. Sold in pairs.

Color options:



Forearm Pads	FPFA4	\$114.63
--------------	-------	----------

CURVED BLOCKING DUMMIES



Reinforced vinyl cover comes with either 3" or 5" Poly-Foam filling. Size: 25" x 18".

Color options:



3" Thick Shield Dummy	FPBS3	\$89.23
5" Thick Shield Dummy	FPBS5	\$100.21

MAN SHIELD



Man-shape provides for more realistic drills. Reinforced vinyl covering, 5" thick molded Poly-Foam core retains shape and lasts longer.

Size: 36" T x 31" W.

Color options:



Man Shield	FPMS5	\$179.49
------------	-------	----------

MAKE

WINNING

POSSIBLE™



LACROSSE



LACROSSE GOALS

OFFICIAL LACROSSE GOAL



Official size 6'H x 6'W x 7'D features 2" HD orange powder-coated galvanized steel frame. One-piece welded face, mitered corners and lacing rail. 3/8" thick flat steel ground bar for goal stability. Includes 7mm nets and lacing cord. Sold as pairs.

Official Size Lacrosse Goal	LGOFF	\$756.67
-----------------------------	-------	----------

DELUXE LACROSSE PRACTICE GOAL



Official size 6'H x 6'W x 7'D features 1.5" powder-coated orange galvanized steel frame. Includes full lacing rail around goal frame and ground supports. Goals include 4mm net and lacing cord. Sold individually.

Deluxe Lacrosse Practice Goal	LGPRACD	\$226.64
-------------------------------	---------	----------

LACROSSE PRACTICE GOAL



Official size 6'H x 6'W x 7'D features 1.5" powder-coated orange galvanized steel frame. Net laces around frame face and ground supports. Goals include 4mm nets and lacing cord. Sold individually.

Lacrosse Practice Goal	LGPRAC	\$204.48
------------------------	--------	----------

LACROSSE GOALS



SILVERLINE PRACTICE LACROSSE GOAL



1.5" powder-coated orange galvanized steel frame. Net laces around frame face and ground supports. 4mm net and lacing cord.
SOLD INDIVIDUALLY.

Practice Partner® Silverline Lacrosse Goal	SLVLG	\$62.56
--	-------	---------

LACROSSE GOAL



Official size lacrosse goal. Formed from 18-gauge, 1.5" powder-coated steel tubing. Includes 3mm, heavy-duty weatherized netting.

Size: 72"W x 72"H x 84"D

Practice Partner® Lacrosse Goal	LGPRAC	\$204.48
------------------------------------	--------	----------

LACROSSE WALL REBOUNDER



Constructed of 1.5" 18-gauge steel tubing with 4' x 3' rebounding surface.

Size: 84"T x 36"W

Practice Partner® Lacrosse Wall Rebounder	LPBT	\$260.96
---	------	----------

LACROSSE NETS



Official size lacrosse nets with choice of heavy-duty 7mm or standard 5mm net.
 Sold individually.

Lacrosse Net - 5mm	LGNET5	\$108.67
Lacrosse Net - 7mm	LGNET7	\$154.43

LACROSSE GOALS

LACROSSE GOAL DOLLY



Move any lacrosse goal on and off the field with ease. Slide the front brackets under the front corners of your goal, tilt back on the handle while also holding the top of the goal, then easily move your goal to its desired location. Push-button assembly.

Lacrosse Goal Dolly	LG000	\$533.38
---------------------	-------	----------

PROLINE LACROSSE FIELD LAYOUT SYSTEM

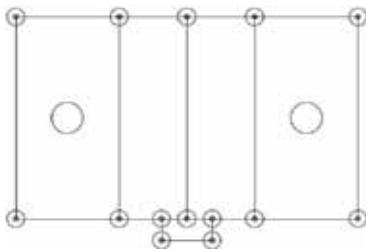

Quickly and easily layout your lacrosse field with this easy to use kit. Measure once and easily re-stripe year after year. Includes 14 sockets, starter tool & 600' of twine.

Proline Lacrosse Field Layout System	LLS14	\$140.45
--------------------------------------	-------	----------

LACROSSE GOAL TARGET



Great for players of all ages and skill levels, the ProCage™ Lacrosse Goal Target is perfect for improving your shooting precision and accuracy! Black vinyl with seven target zones. Includes fasteners to easily attach to your 6' x 6' goal. Goal and net not included.

Lacrosse Goal Target	LGT66	\$75.06
----------------------	-------	---------

30' X 10' MULTI-SPORT BACKSTOP NET



Free-standing backstop is ideal for catching stray balls during you practice sessions or games. Sturdy and durable, the Backstop Net features a 2.5 mm net with 1.25" galvanized steel upright poles. Leg supports provide maximum stability.

30' x 10' Multi-sport Backstop Net	MSBN	\$436.26
------------------------------------	------	----------

AEROSOL FIELD PAINT



Fast-drying, water resistant. Universal tip fits most machines. 12 (20oz.) cans per case. Available in white, red, yellow, purple, royal, navy, black, orange, maroon, turf green, brown, silver, pink & gold.

White Aerosol Field Paint	LINEW	\$91.83
Color Aerosol Field Paint	LINEC	\$94.00

SOCCER



GAMEDAY FIELD EQUIPMENT

SOCCER REBOUNDER 6' X 12'



Large and sturdy 6' x 12' size with powder-coated galvanized steel tube frame. Great for improving shooting strength or accuracy.

Included Accessories:

- 3' stabilizing legs for added stability
- UV treated net
- Bungee cords for attachment.

Soccer Rebounder 6' x 12'	SR612	\$226.64
Soccer Rebounder Replacement Net	SR612N	\$67.91

CORNER FLAG SET CARRY BAG



Features a reinforced vinyl bottom to help prevent spikes from coming through. Holds up to four corner flags.

Corner Flag Set Carry Bag	SCFBAG	\$34.31
---------------------------	--------	---------

PROLINE SOCCER FIELD LAYOUT SYSTEM

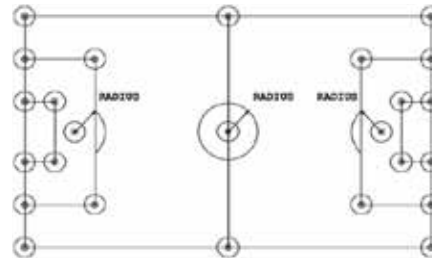

Quickly Mark any size soccer field. Measure once and restripe year after year. Includes 25 locators, starting tool and 600' cord.

Proline Soccer Field Layout System	SLS25	\$337.48
------------------------------------	-------	----------

DELUXE CORNER FLAG SET



1" OD x 60"H flexible PVC upright attached to official red flag. Spring-loaded steel base for easy ground insertion. Set of 4.

Deluxe Corner Flag Set	SCFLAGD	\$97.23
------------------------	---------	---------

SOCCER NETS



All nets come in white or orange with 5" square mesh and meet NCAA, NHSAA and FIFA specifications.

THREAD	SIZE	ITEM #	MRRP
4mm	8' x 24' x 4' x 10"	SN4824	\$351.42
3mm	8' x 24' x 4' x 10"	SN3824	\$281.92
3mm	7' x 21' x 3' x 8'	SN3721	\$210.57
3mm	6.5' x 18' x 3' x 7'	SN3618	\$243.10

SOCCER REFEREE FLAG



Set of 2 soccer linesman flags with a storage bag. Flags include padded handles, fluorescent red and yellow flags with heavy-duty PVC shaft.

Soccer Referee Flag	SREFLAG	\$27.16
---------------------	---------	---------

SOCCER GOALS

PVC PORTABLE SOCCER GOAL W/NET



Perfect for all levels of play. Ultra-tough and durable molded PVC soccer goal comes in two sizes, 3' high x 4' wide or 4' high x 6' wide. Push-button assembly makes for quick and easy setup and take down. Lightweight and sturdy for easy transport. **ALL GOALS SOLD INDIVIDUALLY.**

EACH GOAL INCLUDES:

- PVC Crossbar & Uprights
- Red Net
- PVC Backstays
- 25 Net Clips
- U-Type Anchor stakes
- Carry Bag

3 x 4' Portable PVC Soccer Goal	SGP34	\$142.27
4 x 6' Portable PVC Soccer Goal	SGP46	\$150.25

OFFICIAL ALUMINUM SOCCER GOALS



Aluminum soccer goals come in 4" round or square options. Goal is official 8' x 24' size and meets NCAA, NHSAA, and FIFA specifications. Features extruded aluminum frame that is light-weight & easy to transport and rounded corners for safer play. One-piece welded goal frames. Crossbar & uprights include a net channel for easy net attachment with included net clips. Heavy-duty backstays are 1^{5/8}" galvanized steel. Optional ground anchors recommended to decrease risk of goal tipping over. **ALL GOALS INCLUDE 4MM NETS.**

EACH GOAL INCLUDES:

- Backstays
- Crossbar & Uprights
- 8' x 24' Net
- Net Clips
- One-Piece Ground Bar
- (4) 14" HD Steel Ground Anchors

8' x 24' Round Aluminum Soccer Goal	SG824RD	\$4,671.81
8' x 24' Square Aluminum Soccer Goal	SG824SQ	\$3,961.00
Ground Anchors	SGANCH	\$159.45
Soccer Goal Wheel Kit	SGWK	\$351.38

PORTABLE ALUMINUM CLUB SOCCER GOAL



3" Aluminum club soccer goals available in sizes for all levels of play. 3" round aluminum front face with double reinforced corners, available in powder coated white or natural aluminum, also feature a built in net clip track for easy net installation. Galvanized steel 1.66" OD backstays for added stability. All goals include a 3mm white net and "J" Stake anchors for added safety and stability. Underground or Auger style anchors available at an additional cost. **SOLD IN PAIRS.**

EACH GOAL INCLUDES:

- Crossbar & Uprights
- Hardware
- Built-in net clip track
- "J" Stake anchors
- 3mm white net
- Net clips

U6 4' x 6' Portable Soccer Goal w/ Net	SG3046W	\$2,097.00
U8 6' x 12' Portable Soccer Goal w/ Net - White Finish	SG3612W	\$3,051.62
U8 6' x 18' Portable Soccer Goal w/ Net - White Finish	SG3618W	\$3,241.81
U12 7' x 21' Portable Soccer Goal w/ Net - White Finish	SG3721W	\$3,432.00
U12 8' x 24' Portable Soccer Goal w/ Net - White Finish	SG3824W	\$3,813.81

SILVERLINE SOCCER GOALS



Silverline soccer goal series comes in two sizes: 9'W x 6'H x 4'D and 12'W x 6'H x 4'D. Goals are great for all levels and ages of soccer. Goals are constructed of a 1 5/8" diameter, 18-gauge steel tubing. Includes a professional quality, heavy-duty weatherized net.

Practice Partner® Silverline Soccer Goal 6x9	SLVSG9	\$169.00
Practice Partner® Silverline Soccer Goal 6x12	SLVSG12	\$199.00
Practice Partner® 6'x9' Replacement Soccer Net	SOCNET9	\$85.00
Practice Partner® 6'x12' Replacement Soccer Net	SOCNET12	\$95.00

SOCCER NETS



All nets come in white or orange with 5" square mesh and meet NCAA, NHSAA and FIFA specifications.

THREAD	SIZE	ITEM #	MRSP
4mm	8' x 24' x 4' x 10"	SN4824	\$351.42
3mm	8' x 24' x 4' x 10"	SN3824	\$281.92
3mm	7' x 21' x 3' x 8'	SN3721	\$210.57
3mm	6.5' x 18' x 3' x 7'	SN3618	\$243.10

4' X 8' FOLDING SOCCER GOAL



Foldable goal features push-button assembly and all-weather net. Perfect portable goal for practice.

Size: 4'H x 6'W x 3'D

Practice Partner® Folding Soccer Goal	FOLD95	\$74.36
---------------------------------------	--------	---------

6X9 SOCCER REBOUNDER



Assembles to 6'H x 9'W. Precision-fit locking pins for easy assembly. Constructed of 1.5", 18-gauge heavy-duty steel tubing.

Practice Partner® Soccer Rebounder	SOCREB	\$114.40
------------------------------------	--------	----------

HOCKEY



GOALS / SHOOTING TARGET



PRO DELUXE HOCKEY GOAL



The Practice Partner 72-in Pro Deluxe Hockey Goal helps the scoring-minded players and goaltenders perfect their skills! The goal's durable frame is made of 2-in galvanized steel tubing with weather treated red powder coating. The double welded net attachment system keeps the net squarely fastened together, perfect for indoor and outdoor use.

Practice Partner® Hockey Goal	RHX2	\$107.25
-------------------------------	------	----------

SILVERLINE HOCKEY GOAL



The Practice Partner 72-in Silverline Pro Style hockey goal matches a strong, power-coated steel tubing frame with heavy-duty weatherized netting. It features a securely welded net attachment system and a Pro-Style rounded back.

Practice Partner® Silverline Hockey Goal	SLVRHR	\$120.00
--	--------	----------

HOCKEY GOAL TARGET



NEW!

The Practice Partner hockey goal target is perfect for improving your shooting precision and accuracy. H

Practice Partner® Hockey Goal Target	RHTARGET	\$64.35
--------------------------------------	----------	---------



VOLLEYBALL



OFFICIAL VOLLEYBALL SYSTEM



Meets USVBA, NCAA, and NFHS competition specifications and is designed for any size budget. Posts adjust to Men's (7' 11^{5/8}"), Women's (7' 4^{1/8}"), and Junior's (7') net heights. The ratchet winch easily sets net tension and 5-point net attachment makes set-up quick and easy. Locking collar securely holds net in position. Bottom of uprights feature adjustable, non-marking pads. Upright safety pads included with choice of 14 different colors. Ships truck freight.

Complete Volleyball System	VBATS	\$3,524.95
----------------------------	-------	------------

COMPLETE ONE-COURT SYSTEM INCLUDES:

- (1) 3.5" O.D. Upright
- (1) 3.5" O.D. Upright with Winch
- (2) 3.5" O.D. Floor Sleeves
- (2) Hinged Brass or Chrome Cover Plates
- (1) Collegiate Net with Tensioner
- (1) Pair of Antennas and Sideline Markers
- (2) Upright Safety Pads
- (1) Set of 4 Cable Covers

NET SYSTEMS

PRO VOLLEYBALL NET



3'1/8" x 32' long with 2.5" white headband & vinyl-coated steel cable at top & bottom. Black, 3.0mm knotless netting. Includes side pockets & dowels.

Pro Volleyball Net	VBNETP	\$160.79
--------------------	--------	----------

COLLEGIATE VOLLEYBALL NET



3' x 32' long with 2.5" white headband top only. Vinyl coated steel cable top & nylon roped bottom. Black, 2.6mm braided poly netting.

College Volleyball Net	VBNETC	\$90.02
------------------------	--------	---------

BASIC VOLLEYBALL NET



3' x 32' long with 2.5" white headband. Polyrope cable with taped sides & bottom. Black, 2.6mm braided poly netting.

Basic Volleyball Net	VBNETB	\$61.00
----------------------	--------	---------



UNIVERSAL REFEREE STAND

Sturdy yet lightweight. Works with any volleyball system. Front legs are removable to allow stand to be securely attached to volleyball post with V-bracket and velcro straps. Platform is 44" high with safety rails extending 34" above the platform. Two non-marring wheels allow for easy transport.

Optional padding available. Dense foam covered with reinforced vinyl. Hook and loop attachments.

Padding Available in: Red, Black, Maroon, Forest Green, Royal Blue, Navy Blue, and Purple.



Referee Stand	VRSTND	\$380.02
Referee Stand Padding	VRPAD	\$449.74

ROLLAWAY STANDARDS / TRAINING AIDS

WEIGHTED ROLLAWAY STANDARDS

NEW!
AND IMPROVED DESIGN!



Features heavy-duty steel base powder-coated black with vinyl edge protection and non-marking wheels. Galvanized steel upright is 120" high and includes 2 slide rings for multiple net heights. Sold as pairs. Each base weighs 180 lbs. Ships truck freight.

24" Weighted Standard	VBSTD180	\$648.49
-----------------------	----------	----------

FILLABLE ROLLAWAY STANDARDS



Features heavy-duty steel base with vinyl edge protection & non-marking wheels. Uprights are 8'6" plated steel & feature two multi-purpose ring slides that are height adjustable for multi-use. Base comes in 24" or 30" diameters that can be filled with sand or concrete for added weight. Ships truck freight.

24" Fillable Standard	VBSTD24	\$1,282.91
30" Fillable Standard	VBSTD30	\$1,381.02

TARGET CHALLENGER



12' adjustable pole height with 30" target ring. Includes 22 lb. weight for stability and non-marking wheels for easy mobility. Sturdy net collects balls for easy retrieval. Ideal for passing, setting, or shooting. **BALL CART SOLD SEPARATELY.**

Target Challenger	VBTARGET	\$405.16
-------------------	----------	----------

DELUXE BALL LOCKER



PERFECT FOR VOLLEYBALLS

Full size locker holds 28-30 balls. Heavy steel wire mesh. Powder-coated for durability. Hinged lid can be locked. 4 HD swivel caster wheels.

Size: 42"L x 24"W x 38.5"H

HD Secure Ball Locker	BLOCK	\$260.96
-----------------------	-------	----------

VERTICAL CHALLENGER

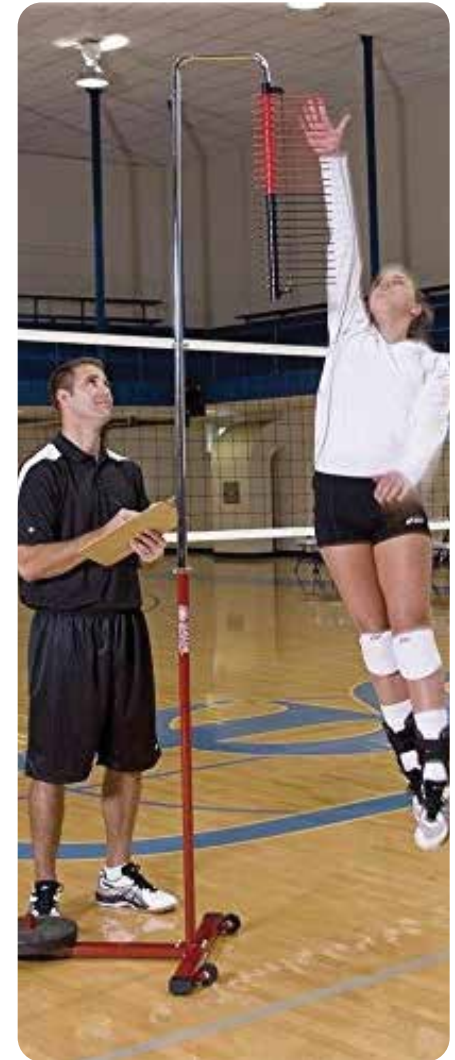

Telescopic pole adjusts from 4-12 feet high. Movable veins spaced 1" apart. Heavy duty base includes weight for stability and non-marking wheels for easy mobility. Includes reset pole.

Vertical Challenger	VBVERT	\$528.36
---------------------	--------	----------

PERFECT FOR INDOOR AND OUTDOOR USE.

Enjoy your practice and take your skills to the next level—rain or shine. Whether you're in your backyard, on the field, at the playground, or in the park, our equipment ensures you can train effectively in all weather conditions.

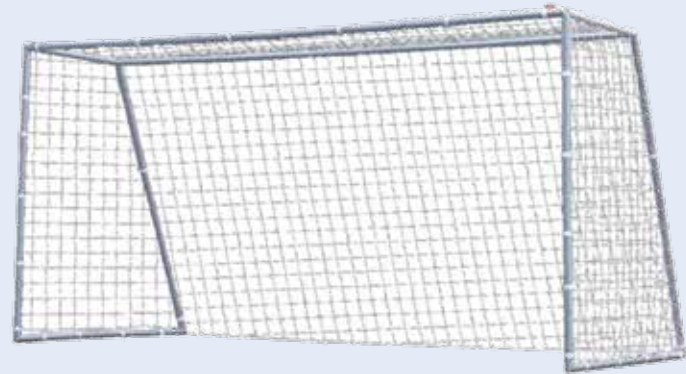

 **PRACTICE PARTNER**

CALL FOR PRICING 888-313-1303

BANNERS & GRAPHICS



SPORTS BANNERS



CHAMPIONSHIP BANNERS

Hang your championships from the rafters. Show fans, prospects, and players what your program has accomplished.

CALL FOR CUSTOM PRICING.



POLE BANNERS

Extend your facility's branding into the parking lot and surrounding campus. Display star players, accomplishments, upcoming events, or your team's logo.

CALL FOR CUSTOM PRICING.



ACHIEVEMENT BANNERS

Display the records of the top individual performers through your team's history. Appliqué construction allows for easy future updates.

CALL FOR CUSTOM PRICING.

WINDOW AND WALL GRAPHICS



Take your facility to the next level with digitally printed vinyl wall graphics. Available in a wide range of materials depending on surface. **CALL FOR CUSTOM PRICING.**

SPORTS FLAGS

CHAMPIONSHIP FLAGS



Take your facility to the next level with digitally printed vinyl wall graphics. Available in a wide range of materials depending on surface.

CALL FOR CUSTOM PRICING.

TEAM FLAGS



Flags with your team's brand elevate any sports facility. Leave players, fans, and passers by with no doubt who's facility they're looking at.

CALL FOR CUSTOM PRICING.

SPIRIT FLAGS



Give your cheerleaders the tools they need to stir up team spirit. Spirit flags of any size are sure to be a hit.

CALL FOR CUSTOM PRICING.

FEATHER FLAGS



Advertise upcoming events, recent accomplishments, and star players. Bring attention to entrances, exits, the box office, and other important areas.

CALL FOR CUSTOM PRICING.

MAKE

WINNING

POSSIBLE™



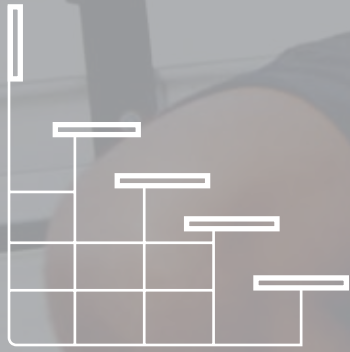

BLEACHERS



BLEACHER ENCLOSURES

Cover the sides and back of your bleachers to provide a unique branding opportunity. Enclosures are custom made to your specifications.

INDOOR ENCLOSURES



Produced from 13 oz. soft-knit polyester, which comes white but is fully digitally printed to match your brand.

CALL FOR CUSTOM PRICING.

OUTDOOR ENCLOSURES



Constructed with 16 oz. ProMesh windscreen for durability and weather resistance. Can be printed with the design of your choice.

CALL FOR CUSTOM PRICING.

STADIUM SEAT COVERS



Enhance your stadium's look with color, texture, and even graphics! Block spectators from sitting in certain areas for specific events. Constructed of vinyl polyester mesh that is available in 13 colors.

Seat Covers are custom made to your specifications.

Color options:



CALL FOR CUSTOM PRICING.



STANDARD ALUMINUM BLEACHERS

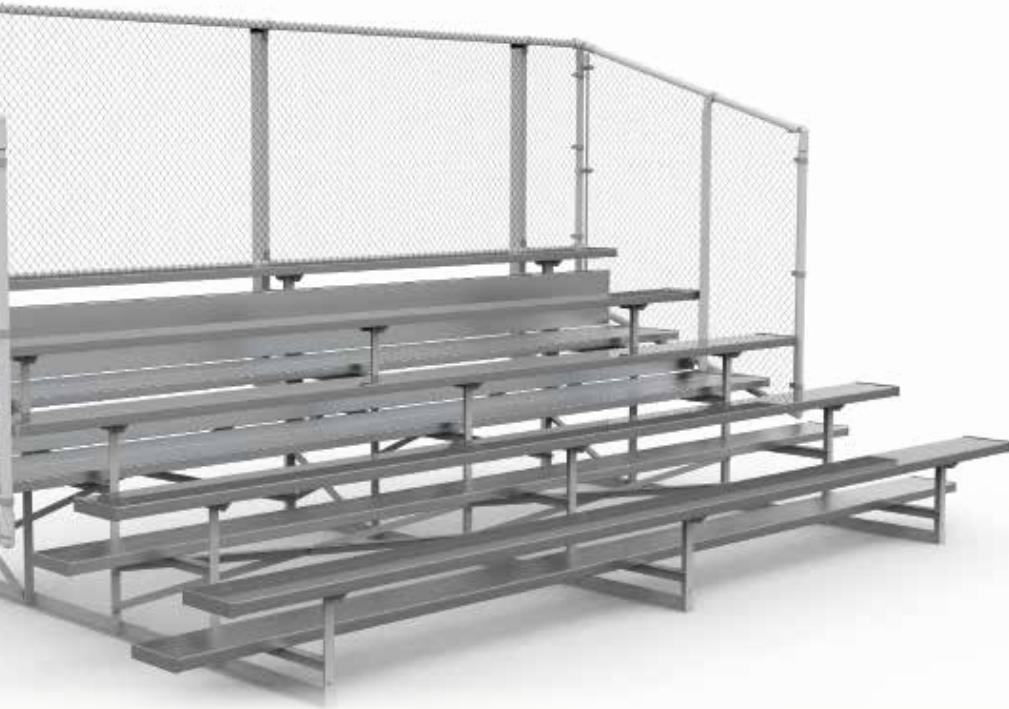

STANDARD FEATURES:

- 2, 3, 4, 5, 8, & 10 Row Units
- 8' Rise/24' Run per Row
- 10' Seat Planks
- 17' Front Row Seat Height
- Available in 15', 21', and 27' Lengths
- Aluminum Frame
- Single Footboards on Rows 2 & 3
- Double Footboards & Risers on Rows 4 & Above
- Preferred Models Feature Double Foot Planks on ALL Rows

ITEM#	SEATS	ROWS	LENGTH	DEPTH	GUARD RAIL	MRSP	PREFERRED MODEL	MRSP
BL315S	30	3	15'	3'	N	\$2,571.37	BL315SD	\$2,784.04
BL321S	42	3	21'	3'	N	\$3,123.12	BL321SD	\$3,878.62
BL327S	54	3	27'	3'	N	\$4,217.70	BL327SD	\$4,845.30
BL415S	40	4	15'	7'	Y	\$6,949.80	BL415SD	\$7,245.32
BL421S	56	4	21'	7'	Y	\$7,245.32	BL421SD	\$5,971.11
BL427S	72	4	27'	7'	Y	\$6,301.27	BL427SD	\$7,355.69
BL515S	50	5	15'	9.5'	Y	\$6,905.07	BL515SD	\$10,261.68
BL521S	70	5	21'	9.5'	Y	\$10,746.45	BL521SD	\$11,104.92
BL527S	90	5	27'	9.5'	Y	\$12,691.76	BL527SD	\$13,584.08
BL815S	80	8	15'	15.2'	Y	\$16,159.00	BL815SD	\$15,386.57
BL821S	112	8	21'	15.2'	Y	\$19,089.70	BL821SD	\$19,770.84
BL827S	144	8	27'	15.2'	Y	\$24,665.21	BL827SD	\$25,645.28
BL1015S	100	10	15'	29.5'	Y	\$18,509.69	BL1015SD	\$19,010.88
BL1021S	140	10	21'	29.5'	Y	\$23,793.71	BL1021SD	\$24,486.35
BL1027S	180	10	27'	29.5'	Y	\$30,770.17	BL1027SD	\$31,741.31

ELEVATED BLEACHERS

PLEASE CALL WITH YOUR SPECIFICATIONS AND MEASUREMENTS FOR QUOTES ON ELEVATED ALUMINUM BLEACHERS!



LOW-RISE BLEACHERS



STANDARD FEATURES:

- 3 & 4 Row Units
- Aluminum Frame
- 6' Rise/24' Tread Depth
- Single Footboards
- 12' Seat Planks
- 12' Front Row Seat Height
- Preferred Models Feature Double Foot Planks on ALL Rows

ITEM#	SEATS	ROWS	LENGTH	DEPTH	HEIGHT	MRSP	PREFERRED MODEL	MRSP
BL315LR	30	3	15'	5'	22.5"	\$2,337.88	BL315LRD	\$2,382.58
BL321LR	42	3	21'	5'	22.5"	\$3,081.48	BL321LRD	\$3,878.62
BL415LR	40	4	15'	7'	28.5"	\$3,558.87	BL415LRD	\$4,356.01
BL421LR	56	4	21'	7'	28.5"	\$4,886.94	BL421LRD	\$5,971.11
BL427LR	72	4	27'	7'	28.5"	\$6,301.27	BL427LRD	\$7,355.69

TIP & ROLL BLEACHERS



STANDARD FEATURES:

- Rubber foot pads to protect floors
- Aluminum angle frames for easier tipping
- 6' Rise/24" Tread Depth
- 2' x 10" Anodized Seat Planks (2" x 12" on 4-row model)
- 2' x 10" Mill Finished Foot Planks
- 5" Locking Swivel Caster Wheels for easy rolling
- Preferred Models Feature Double Foot Planks on ALL Rows

ITEM#	SEATS	ROWS	LENGTH	DEPTH	HEIGHT	MRSP	PREFERRED MODEL	MRSP
BL27.5TR	10	2	7.5'	36"	36"	\$1,149.61	BL27.5TRD	\$1,250.74
BL215TR	20	2	15'	36"	36"	\$1,665.66	BL215TRD	\$1,881.31
BL221TR	28	2	21'	36"	36"	\$2,230.80	BL221TRD	\$2,602.60
BL37.5TR	15	3	7.5'	36"	36"	\$1,499.10	BL37.5TRD	\$1,743.00
BL315TR	30	3	15'	60"	60"	\$2,443.47	BL315TRD	\$2,974.40
BL321TR	42	3	21'	60"	60"	\$3,378.92	BL321TRD	\$4,089.80
BL47.5TR	20	4	7.5'	84"	84"	\$2,337.88	BL47.5TRD	\$2,635.32
BL415TR	40	4	15'	84"	84"	\$3,655.54	BL415TRD	\$4,409.55

ADDITIONAL MATERIAL SURCHARGES MAY APPLY

SUPREME SERIES BLEACHERS



STANDARD FEATURES:

- 4, 5, 8, & 10 Row Units
- Double Footboards & Risers on ALL Rows
- 8' Rise/24' Tread per Row
- Aisle with Anodized Handrails
- 10' Seat Planks
- Aluminum Frame
- 17" Front Row Seat Height
- Chainlink Guardrail

INSTALLATION AVAILABLE - CALL FOR DETAILS

ITEM#	SEATS	ROWS	LENGTH	DEPTH	MRSP
BL421SP	50	4	21'	7'-0"	\$0
BL427SP	66	4	27'	7'-0"	\$0
BL515SP	42	5	15'	9'-5"	\$12,004.68
BL521SP	58	5	21'	9'-5"	\$14,660.82
BL527SP	74	5	27'	9'-5"	\$16,570.38
BL815SP	66	8	15'	15'-2"	\$19,544.78
BL821SP	91	8	21'	15'-2"	\$25,056.35
BL827SP	116	8	27'	15'-2"	\$28,894.81
BL1015SP	82	10	15'	29'-5"	\$22,901.39
BL1021SP	113	10	21'	29'-5"	\$27,873.10
BL1027SP	144	10	27'	29'-5"	\$35,353.72
BL1030SP	164	10	30'	29'-5"	\$0

ADA COMPLIANT BLEACHERS

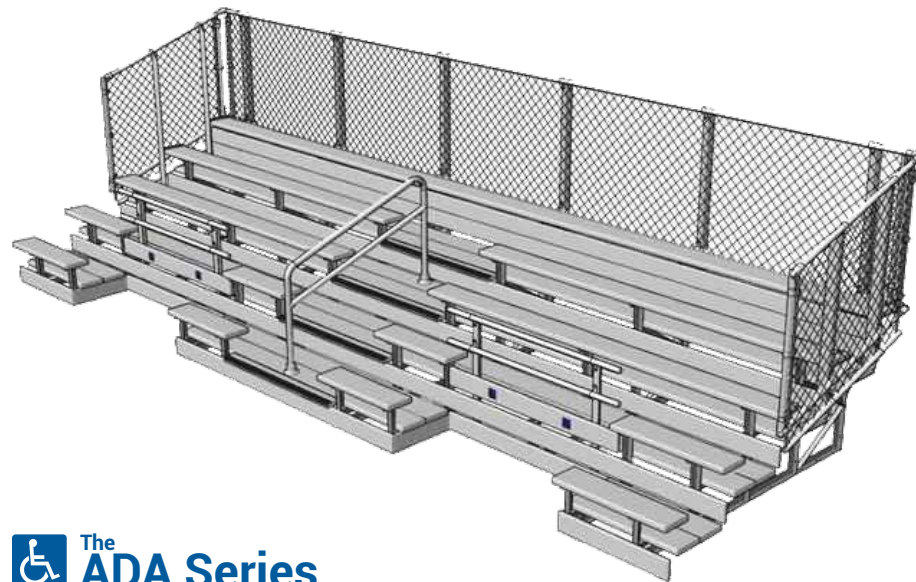

STANDARD FEATURES:

- 5 Row Units
- Double Footboards & Risers on ALL Rows
- 8' Rise/24' Tread per Row
- Aisle with Anodized Handrails
- 10' Seat Planks
- Aluminum Frame
- Chainlink Guardrail
- Open First Row Wheelchair Accessible Area
- Meets Code Including ADA Seating

ITEM#	SEATS	LENGTH	DEPTH	MRSP
BL515HC	34+2 HC	15'	9' 5"	\$12,053.76
BL519.5HC	45+2 HC	19' 6"	9' 5"	\$14,574.56
BL521HC	48+2 HC	21'	9' 5"	\$15,120.36
BL527HC	58+4 HC	27'	9' 5"	\$19,770.84

ALUMINUM TEAM BENCHES



Heavy-duty player's benches featuring anodized aluminum seat planks and optional anodized backrests. The galvanized legs are a heavy 23/8" O.D. pipe built for maximum strength. Legs are all aluminum for no rust and extreme durability.

ITEM#	DESCRIPTION	MOUNT TYPE	FRAME TYPE	WEIGHT	MRSP
PB08PB	8' Bench with Back	Portable	Galvanized Steel	135 lbs	\$837.29
PB08P	8' Bench without Back	Portable	Galvanized Steel	66 lbs	\$502.67
PB08SM	8' Bench without Back	Surface Mount	Galvanized Steel	59 lbs	\$383.70
PB08SMB	8' Bench with Back	Surface Mount	Galvanized Steel	95 lbs	\$663.29
PB08IG	8' Bench without Back	In-Ground Mount	Galvanized Steel	62 lbs	\$365.85
PB08IGB	8' Bench with Back	In-Ground Mount	Galvanized Steel	102 lbs	\$722.78
PBS08	8' Bench with Back & Shelf	Surface/Portable	Aluminum	135 lbs	\$1,020.22
PB15PB	15' Bench with Back	Portable	Galvanized Steel	187 lbs	\$1,305.76
PB15P	15' Bench without Back	Portable	Galvanized Steel	92 lbs	\$1,305.76
PB15SM	15' Bench without Back	Surface Mount	Galvanized Steel	81 lbs	\$642.47
PB15SMB	15' Bench with Back	Surface Mount	Galvanized Steel	143 lbs	\$1,093.09
PB15IG	15' Bench without Back	In-Ground Mount	Galvanized Steel	85 lbs	\$542.83
PB15IGB	15' Bench with Back	In-Ground Mount	Galvanized Steel	150 lbs	\$11,139.91
PBS15	15' Bench with Back & Shelf	Surface/Portable	Aluminum	198 lbs	\$1,762.33
PB21PB	21' Bench with Back	Portable	Galvanized Steel	261 lbs	\$1,588.33
PB21P	21' Bench without Back	Portable	Galvanized Steel	140 lbs	\$968.17
PB21SM	21' Bench without Back	Surface Mount	Galvanized Steel	126 lbs	\$868.52
PB21SMB	21' Bench with Back	Surface Mount	Galvanized Steel	211 lbs	\$1,509.51
PB21IG	21' Bench without Back	In-Ground Mount	Galvanized Steel	132 lbs	\$733.19
PB21IGB	21' Bench with Back	In-Ground Mount	Galvanized Steel	220 lbs	\$1,518.43
PBS21	21' Bench with Back & Shelf	Surface/Portable	Aluminum	279 lbs	\$2,244.18



488 CUMBERLAND STREET

MEMPHIS, TN 38112

trigonsports.com • 888-313-1303



Are you interested in becoming a

TEAM DEALER?

CONTACT US

888-313-1303 • sales@trigonsports.com

Visit trigonsports.com for current pricing

MAKE WINNING POSSIBLE™

